

# VC-TR30

## Auto Tracking Camera

(PTZ Video Camera)

### User Manual - English

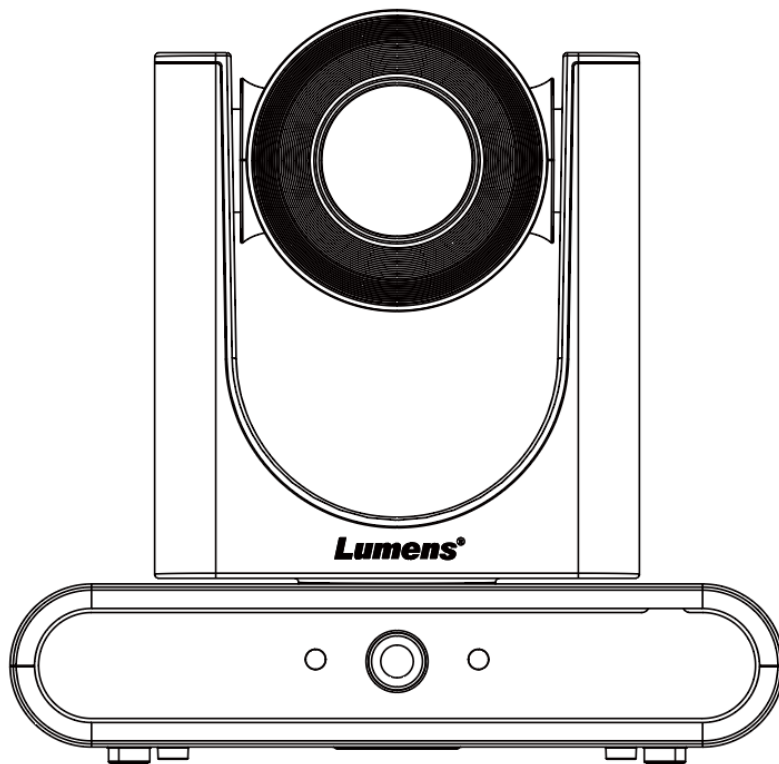

**[Important]**

To download the latest version of Quick Start Guide, multilingual user manual, software, or driver, etc., please visit Lumens  
<https://www.MyLumens.com/support>

# Table of Contents

<b>Chapter 1 Package Contents</b> .....	<b>2</b>
<b>Chapter 2 Product appearance</b> .....	<b>3</b>
2.1 I/O functions Introduction.....	3
2.2 Description of LED indicator .....	3
<b>Chapter 3 Instruction for installation</b> .....	<b>4</b>
3.2 Preparation before installation.....	4
3.3 Instruction for installation .....	4
3.4 Connecting devices.....	7
<b>Chapter 4 Remote Control and Setting Menu</b> .....	<b>9</b>
4.1 Remote Control.....	9
4.2 Setting Menu .....	10
<b>Chapter 5 Network Function Settings Description</b> .....	<b>13</b>
5.1 Connecting Camera to Network .....	13
5.2 Web Page Menu Function Description .....	15
<b>Chapter 6 Troubleshooting</b> .....	<b>32</b>
<b>Chapter 7 Safety Instructions</b> .....	<b>33</b>
<b>Supplier's Declaration of Conformity 47 CFR § 2.1077 Compliance Information</b> .....	<b>35</b>
<b>Copyright Information</b> .....	<b>36</b>

# Chapter 1 Package Contents

---

**Camera**

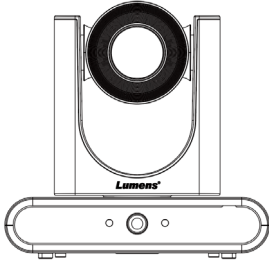

**Remote Control**

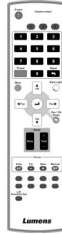

**RS-232/RS-422  
Connection  
Instruction**



**Power Cord**

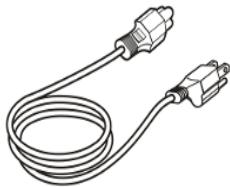

Appearance may vary  
depending on country/ region

**Power Adapter**

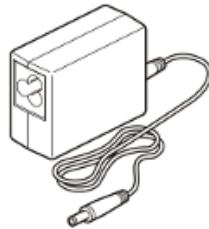

**3-PIN to 2-PIN  
connector**

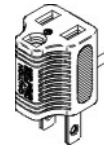

(For Japan only)

**USB 3.0 cable - 2 M  
(Type B to Type A)**



# Chapter 2 Product appearance

## 2.1 I/O functions Introduction

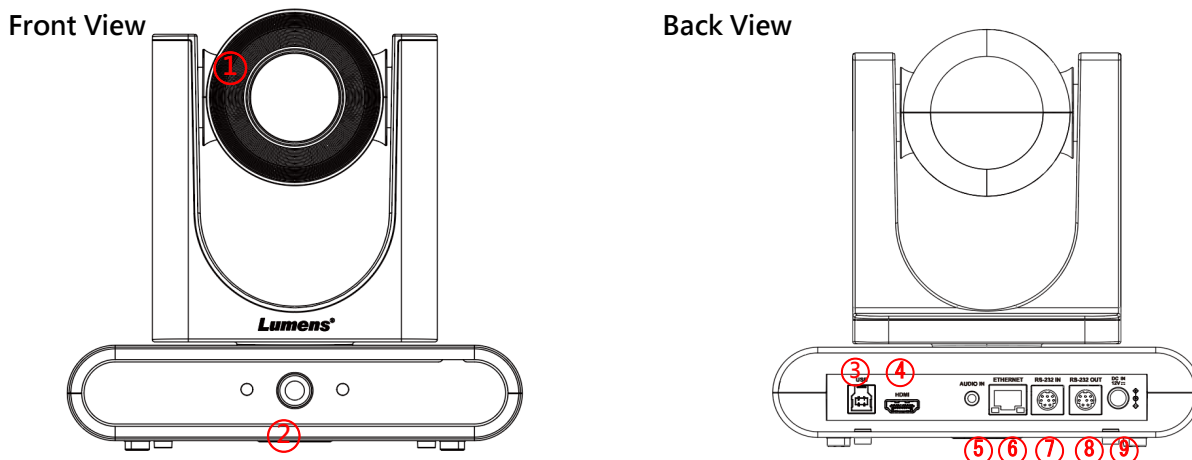

NO.	Item	Function Descriptions
1.	Main camera lens	HD camera lens
2.	Panoramic lens	Panoramic camera lens
3.	USB3.0 Port	The USB port is for connecting to the USB port of the computer and providing USB signal images
4.	HDMI output	HDMI output (Audio output supported)
5.	Audio In	3.5 mm LINE IN
6.	Network port	Network cable port, supporting PoE (IEEE802.3af) power supply
7.	RS-232 input	RS-232 input port, at most 7 cameras can be connected in a serial connection
8.	RS-232 output	RS-232 output port, at most 7 cameras can be connected in a serial connection
9.	DC 12 V power Port	DC supply connecting port

## 2.2 Description of LED indicator

Status	Power	Standby
Startup in progress	Green light	Orange light
In use	Green light	No indicator
In standby mode	No indicator	Orange light
Tracking / Framing mode	Flickering green light	Flickering green light

# Chapter 3 Instruction for installation

## 3.1.1 Scenario

3.1.2 Applicable distance range of VC-TR30: 2 - 12 m, best tracking target distance recommended: 8 m

3.1.3 Mounting height: 2 - 3 m, best height recommended: 2.4 m

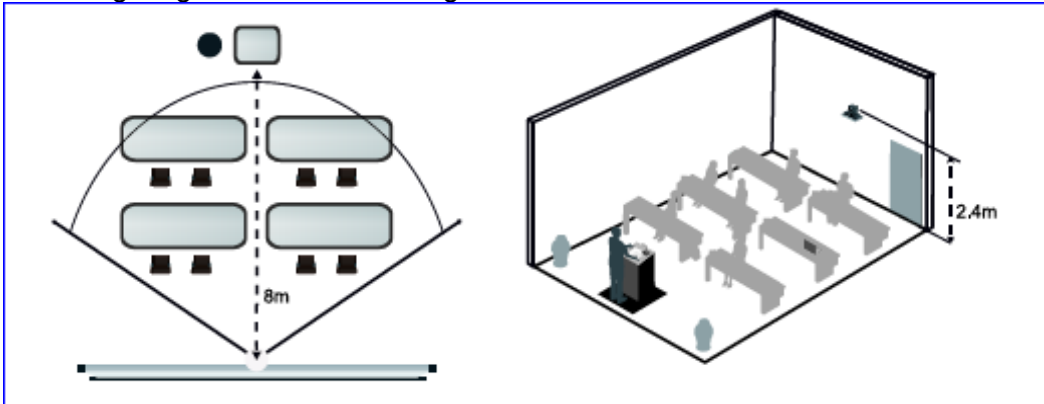

<Note> For maintaining the best tracking results, please avoid images of people on posters, screens, monitors, TVs in the background

## 3.2 Preparation before installation

Installation and connection of HD camera requires special skills. To install by yourself, please follow necessary steps, ensure steady and tight installation of the device, and pay attention to your safety to avoid any accident.

3.2.1 Ensure the safety of the installation environment. Please do not install the device on unstable ceiling or in a place where the device is in danger of falling to avoid any accident.

3.2.2 Please check whether accessories in the box are complete or not. Please contact the supplier for any shortage, and make sure to keep the accessories in the box intact.

3.2.3 Please choose a proper place for installation of camera in advance. Please determine an installation place according to the following requirements

3.2.3.1 Confirm the position for the object to be captured.

3.2.3.2 Confirm whether the camera is set at a proper distance from other light sources.

## 3.3 Instruction for installation

3.3.1 I would like to install camera on the desk

3.3.1.1 Precautions for installation

- Please install the machine on a flat desk
- Do not grab the camera head by hand when handling the device
- Do not rotate the camera head by hand. Improper rotation may result in breakdown of the camera

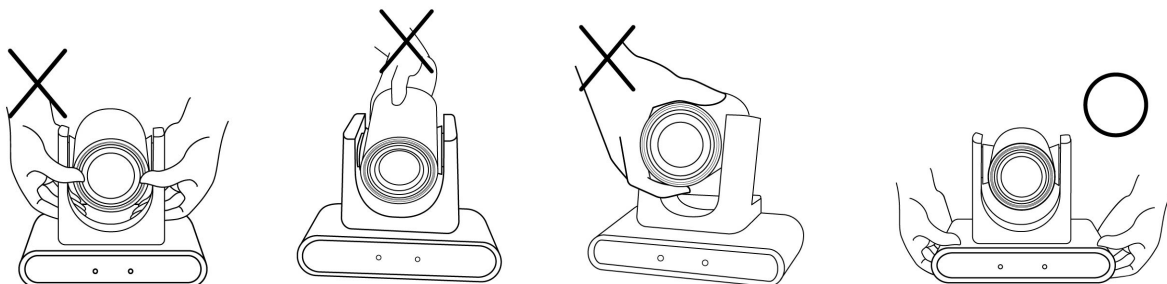

### 3.3.2 I would like to install the camera on the ceiling/wall/TV stand

Lumens can provide the following optional accessories. Please contact your Lumens distributor if needed for purchase

- VC-WM14 3 in 1 Folding Bracket
- VC-WM15 Ceiling Mounted Bracket

For installation of brackets, please download [VC-WM14/VC-WM15 Quick Installation Guide](#) from the Lumens website

#### ◆ Install on the TV

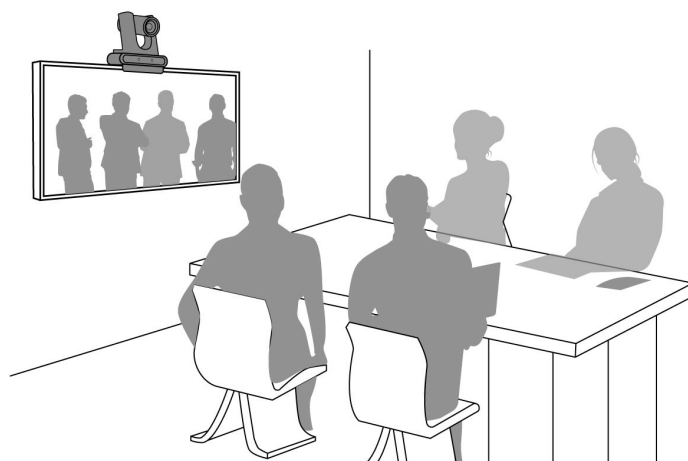

#### ◆ Install on the ceiling

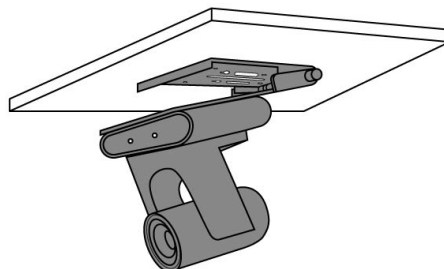

#### ◆ Install on the wall

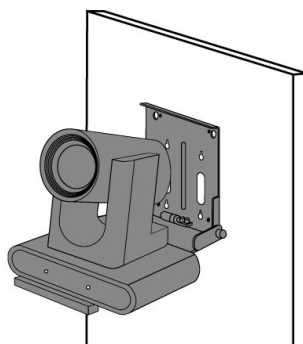

### 3.3.3 Camera Size

- Length x Width x Height: 190 x 137.4 x 185 mm
- Weight: 1.3 Kg

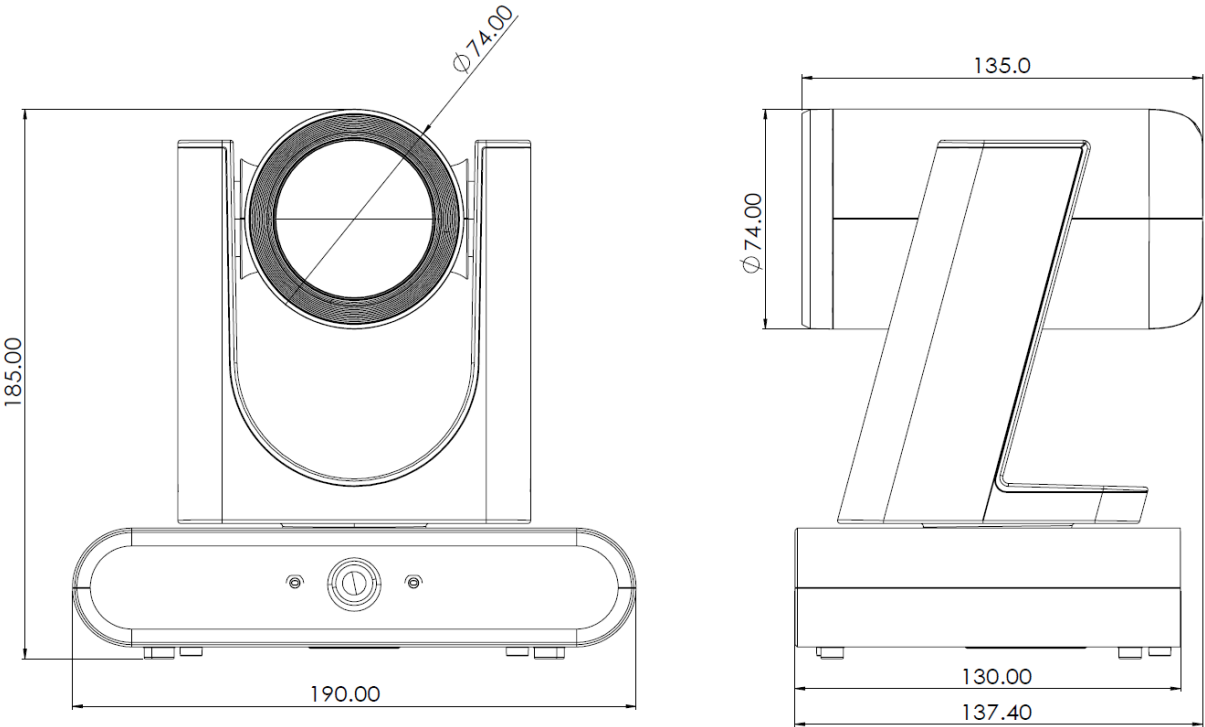

### 3.3.4 Dimensions of the bottom of the machine

The camera can be mounted on a 1/4"-20 UNC PTZ tripod deck by using the lock holes on the bottom for the tripod

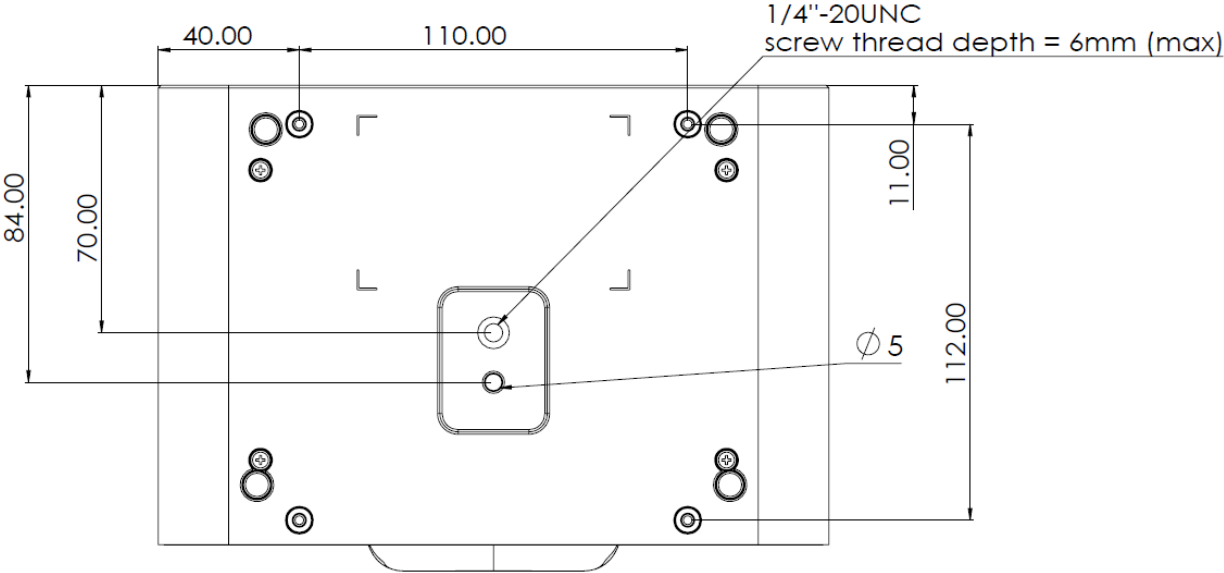

### 3.4 Connecting devices

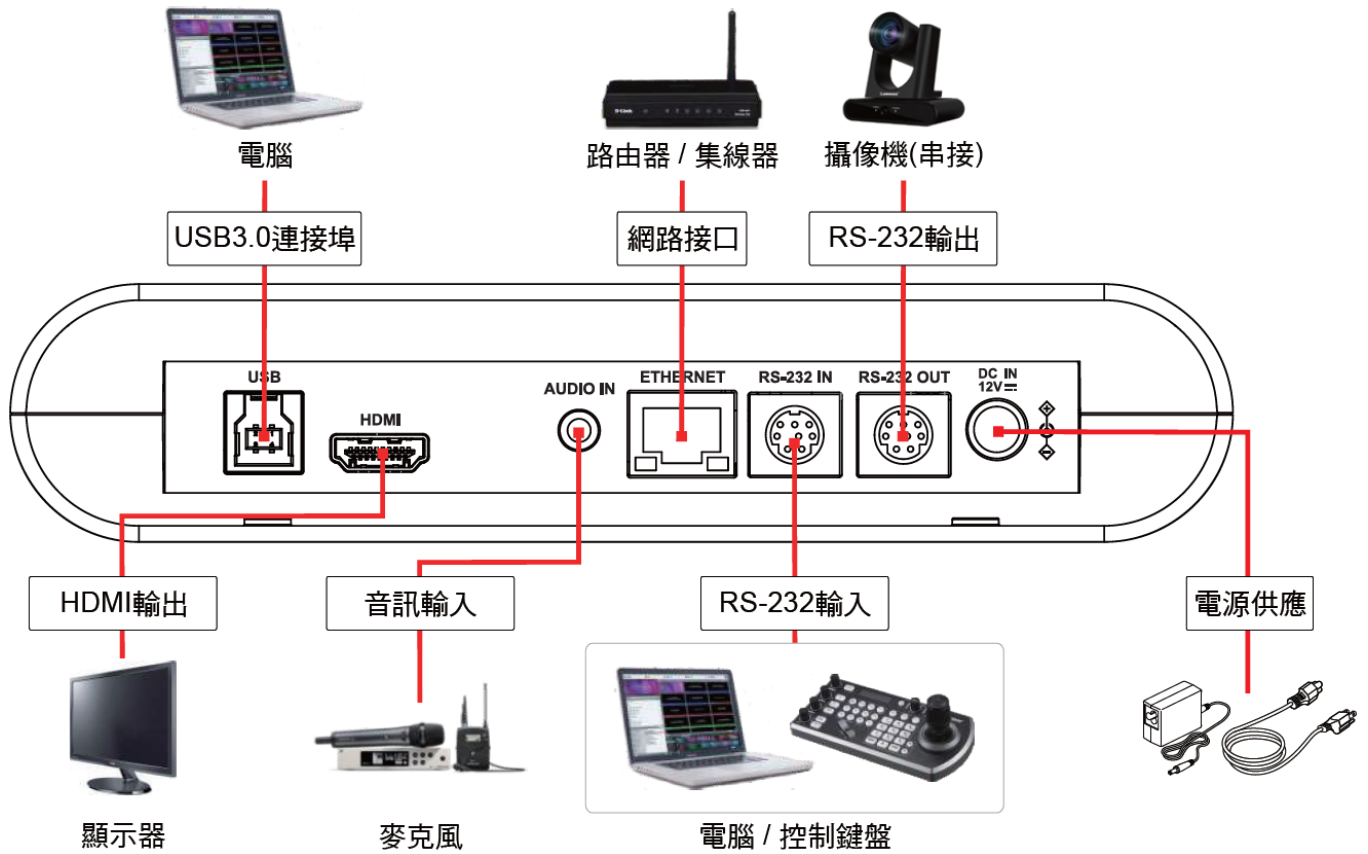

<Remark> Network cable port, supporting PoE (IEEE802.3af) power supply

#### 3.4.1 RS-232 connection (up to 7 Lumens cameras)

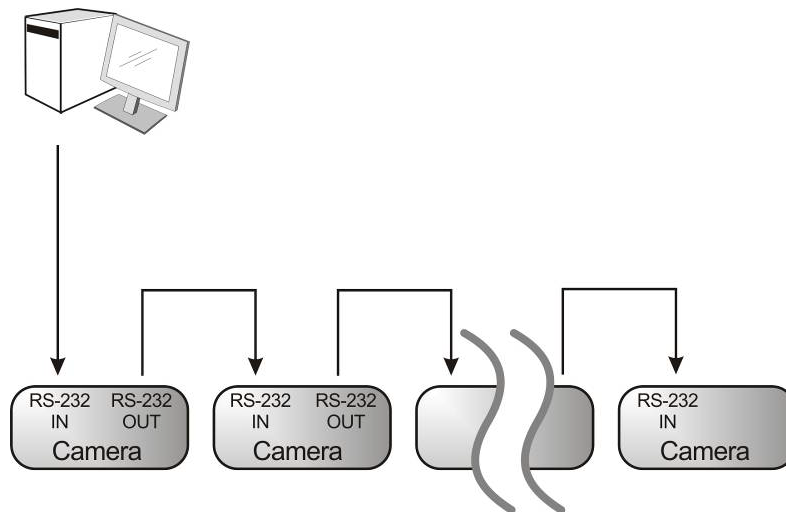



■ RS-232 pins definition instructions

▼ RS-232 IN Pins Instructions

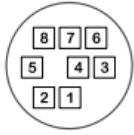

NO	Pins	Signals
1	DTR	Data Transmission Reade
2	DSR	Data Set Reade
3	TXD	Transmit Data
4	GND	Ground
5	RXD	Receive Data
6	GND	Ground
7	IR OUT	IR Commander Signal
8	N.C.	No Connection

▼ RS-232 OUT Pins Instructions

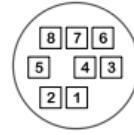

NO	Pins	Signals
1	DTR	Data Transmission Reade
2	DSR	Data Set Reade
3	TXD	Transmit Data
4	GND	Ground
5	RXD	Receive Data
6	GND	Ground
7	OPEN	Reserved
8	OPEN	Reserved

▼ RS-232 Connection Instructions

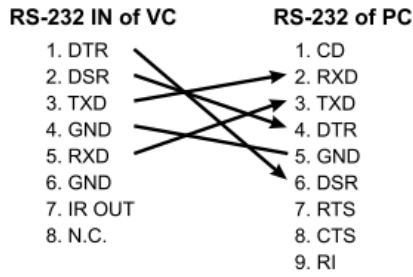

▼ RS-232 Connection Instructions

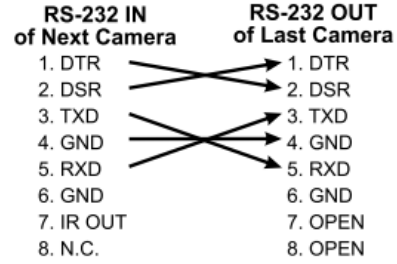

# Chapter 4 Remote Control and Setting Menu

## 4.1 Remote Control

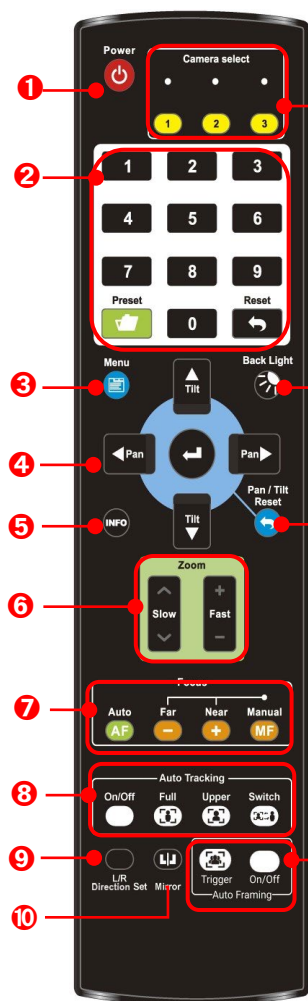

編號	項目	說明
1.	Power	Power Switch
2.	Preset	<ul style="list-style-type: none"> <li>■ Numeric Keys 0 - 9: Click to call the preset</li> <li>■ Preset: Appoint an ID (0 ~ 9) to save the current position data</li> <li>■ Reset: Appoint an ID (0 ~ 9) to delete the current position data</li> </ul>
3.	Menu	Display OSD menu
4.	Pan/ Tilt/ Enter	<ul style="list-style-type: none"> <li>■ Pan/Tilt: Move the lens</li> <li>■ Home-Enter: Go back to the main page / Execute</li> </ul>
5.	Info	Status information
6.	Zoom	<ul style="list-style-type: none"> <li>■ Fast: Adjust image size</li> <li>■ Slow: Fine-tune image size</li> </ul>
7.	Focus	<ul style="list-style-type: none"> <li>■ Auto: Auto focus</li> <li>■ Manual: Enable Manual Focus</li> <li>■ Far/Near: Adjust the focal length in Manual</li> </ul>
8.	Auto Tracking	<ul style="list-style-type: none"> <li>■ On/Off: Enable/Disable Auto Tracking</li> <li>■ Full: Full body tracking</li> <li>■ Upper: Half body tracking</li> <li>■ Switch: Switch tracking object</li> </ul>
9.	L/R Direction Set	L/R Direction / Normal
10.	Mirror	Rotate the image (OFF / Mirror / Flip / Rotate)
11.	Camera select	Choose Camera ID 1 ~ 3
12.	Back Light	Turn on/off back light compensation
13.	Pan/Tilt Reset	Clear the Pan/Tilt setting
14.	Auto Framing	<ul style="list-style-type: none"> <li>■ On/Off: Enable/Disable auto framing</li> <li>■ Trigger: Manual framing correction</li> </ul>

## 4.2 Setting Menu

<Remark> Press [**MENU**] on the **remote control** to enter the setting menu; the **bold underlined** values in the following table are defaults.

1st Level Major Items	2nd Level Minor Items	3rd Level Adjustment Values	Function Descriptions	
Exposure	Mode	<u>Full Auto</u> / Shutter Pri/ Iris Pri/ Manual/ White Board	Exposure mode setting	
	Exposure Comp.	On/ <u>Off</u>	Turn on/off Exposure Comp.	
	Exposure Comp. Level	-6~ <u>C</u> ~4	Adjustable after <b>Exposure Comp.</b> is activated	
	Spot Light	On/ <u>Off</u>	Turn on/off Spot Light	
	Spot Light Position	X(0~6)Y(0~4)	Adjustable after <b>Spot Light</b> is activated	
	Anti-Flicker	50Hz/ 60Hz/ Off	Enable/ Disable Anti-Flicker	
	Shutter Speed	60/30mode	50/25mode	Adjustable when the <b>Exposure mode</b> is set to <b>Shutter Pri</b> or <b>Manual</b>
		1/10000~1/25		
	Iris Level	F1.6~ <u>C</u> ~F14/ Close	Adjustable when the <b>Exposure mode</b> is set to <b>IRIS Pri</b> or <b>Manual</b>	
	Gain Limit	8~ <u>30</u> dB	Max. limit value of electron gain	
	Gain Level	<u>0</u> ~30dB	Adjustable when the <b>Exposure mode</b> is set to <b>Manual</b>	
WDR	<u>Off</u> / 1/ 2/ 3	WDR settings		
White Balance	Mode	<u>1.Auto</u> 2.Indoor 3.Outdoor 4.One Push WB 5.ATW 6.Manual 7.Sodium Lamp	Select the color temperature mode 1. 4000k ~ 7000k 2. 3200k 3. 5800k 4. 1700k ~ 10000k 5. 1700k ~ 10000k 6. Custom 7. 2800k	
	One Push Trigger	<u>ENTER</u>	One push trigger	
	Manual Red	0~ <u>C</u> ~127	Adjustable when the white balance mode is set to <b>Manual</b>	
	Manual Blue	0~ <u>C</u> ~127	Adjustable when the white balance mode is set to <b>Manual</b>	
Tracking	Type	<u>Auto Tracking</u> / Auto Framing		
Picture	2D NR	Off/ <u>1</u> / 2/ 3	2D noise reduction	
	3D NR	Off/ Low/ <u>Typ</u> / Max	3D noise reduction	
	Image Mode	<u>Default</u> / Custom	The user may customize his/her desired image mode	
	Brightness	0~ <u>A</u> ~15	Adjustable when the <b>Image Mode</b> is set to <b>Custom</b>	
	Hue	0~ <u>A</u> ~15	Adjustable when the <b>Image Mode</b> is set to <b>Custom</b>	
	Saturation	0~ <u>A</u> ~15	Adjustable when the <b>Image Mode</b> is set to <b>Custom</b>	
	Gamma	0~ <u>A</u> ~3	Adjustable when the <b>Image Mode</b> is set to <b>Custom</b>	
	Sharpness	0~ <u>A</u> ~14	Adjustable when the <b>Image Mode</b> is set to <b>Custom</b>	
Pan Tilt	Pan/Tilt Limit	On/ <u>Off</u>	Turn on/off the angle limit setting	

1st Level Major Items	2nd Level Minor Items	3rd Level Adjustment Values	Function Descriptions
Zoom	Pan Right Limit	0~ <b>170</b>	Limit the right angle
	Pan Left Limit	<b>-170</b> ~0	Limit the left angle
	Tilt UP Limit	0~ <b>90</b>	Limit the upward angle
	Tilt Down Limit	<b>-30</b> ~0	Limit the downward angle
	Pan Flip	On/ <b>Off</b>	After it is activated, the Pan command will be reverse
	Tilt Flip	On/ <b>Off</b>	After it is activated, the Tilt command will be reverse
	Preset Speed	5/ 25/ 50/ 80/ <b>120</b> deg/sec	Set the rotation speed of the cradle head when Preset is executed
	PTZ Speed Comp	On/ <b>Off</b>	After it is activated, the Pan/Tilt moving speed will vary from the zoom position
	D-Zoom Limit	<b>x1</b> ~x12	Set the D-zoom limit
D-Effect	Mirror	<b>Off</b> / Mirror/ Flip/ Mirror+Flip	Set the mode at which the image is turned
Auto Focus	AF Sensitivity	Low/ <b>Middle</b> / High	For AF triggering speed, the higher the sensitivity is, the faster AF is triggered
	AF Frame	Center/ Full Frame/ <b>Auto</b>	AF frame setting, when <b>Center</b> was set as AF frame, focusing will be on the center of the screen. When Full Frame was set as AF frame, focusing will be calculated based on the full screen
Ethernet	DHCP	<b>On</b> /Off	Enable/Disable the dynamic host configuration
	IP Address	<b>192.168.100.100</b>	Configurable when <b>DHCP</b> is set to <b>Off</b>
	Subnet mask	<b>255.255.255.0</b>	
	Gateway	<b>192.168.100.254</b>	
Audio	Audio Enable	On/ <b>Off</b>	Turn on/off audio output
	Audio In	<b>Line In</b> / Mic In	
	Audio Volume	0~ <b>A</b> ~10	Volume Setting
	Audio Delay	On/ <b>Off</b>	When the audio is not synchronized with the video, enable this function to set the audio delay time
	Audio Delay Time(ms)	<b>-10</b> ~-500ms	Set audio delay time
	Encode Sample Rate	<b>48 KHz(AAC)</b>	Set the encode type and sample rate
System	Prompt	On/ <b>Off</b>	Turn on/off the prompt information on the display
	IR Receive	<b>On</b> /Off	Turn on/off the infrared reception When it is Off, the remote control will not be able to control the camera. At this moment, turn off and then turn on the power to restore control of the remote control.

1st Level Major Items	2nd Level Minor Items	3rd Level Adjustment Values	Function Descriptions
	IR Select	<u>1</u> / 2/ 3	Camera IR Select setting must be the same setting as the Camera Select of the remote control to control the camera
	Tracking Led Status	<u>On/ Off</u>	When enabled, LED on the front panel will flash green in a slow blinking while the camera is tracking.
	Language	<u>English</u> / Chinese	
	Initial Position	<u>Last MEM</u> / 1st Preset	After turning on the camera, you can select the lens to be returned to <u>Last MEM</u> or <b>1st Preset</b> <b>&lt;Remark&gt; 1st Preset =Preset 0</b>
	Motionless Preset	On/ <u>Off</u>	When the function is enabled, the screen will Freeze when <b>Preset</b> is executed. Freeze will be released after <b>Preset</b> is completed
	Privacy Mode	On/ <u>Off</u>	Enable/Cancel Privacy Mode After the function is enabled, when the camera is turned off via the remote control or software, the lens will automatically turn to the bottom right to ensure the user's privacy
	Protocol	<u>VISCA</u>	Supporting VISCA protocol
	Baud Rate	<u>9600</u> /38400	Choose the transmission speed of the control signal
	VISCA Address	<u>1~7</u>	The camera ID address can be assigned. Select 0 for automation.
	Output Mode	<u>1080p 60</u> /50/30/25 720p 60/50/	Choose the output resolution
	Factory Reset)	<b>Confirm</b>	Resume the factory default setting
Status			Display the current setting status

# Chapter 5 Network Function Settings Description

## 5.1 Connecting Camera to Network

### 5.1.1 Connecting to Internet

Two common connection methods are shown below

1. Connecting via switch or router

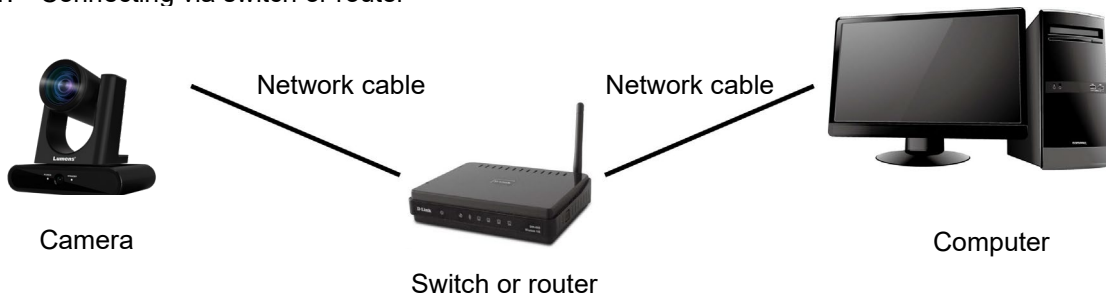

2. To connect directly through network cable, the IP address of the computer should be changed so that it is on the same network segment as the camera

**E.g.:** The factory-preset default IP address of the camera is 192.168.100.100. The computer IP address must be set with the same network segment, such as 192.168.100.101, so that the computer can be connected correctly with the camera

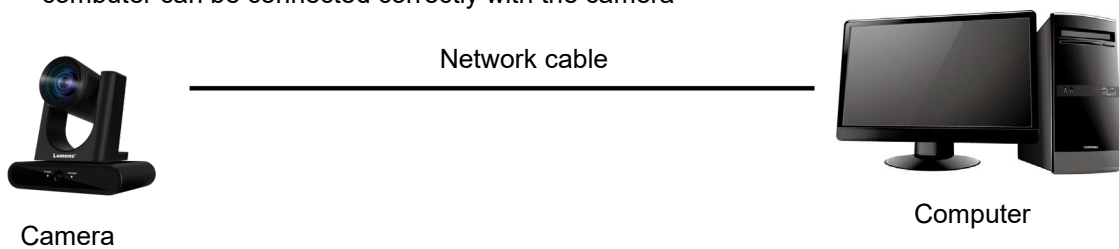

- Change network settings

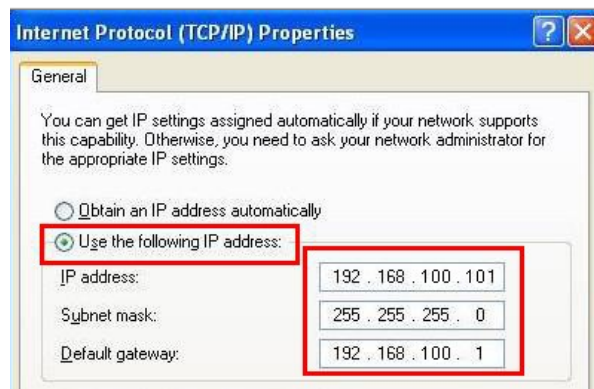

### 5.1.2 Using the Browser to View the Images

- Open the browser, and enter the IP address of the camera in the address bar  
E.g.: <http://192.168.100.100> (default IP address)
- Enter administrator's account and password

<Remark> For the first-time login, please refer to [5.2.10 System Settings - User](#) to change the default password

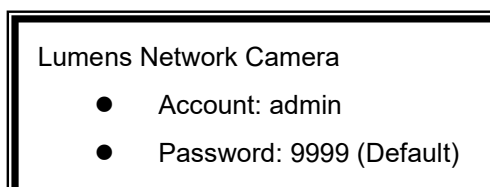

### 5.1.3 Using RTSP Player to View the Images

Free software can be used for RTSP connection, such as VLC, Quick Time and PotPlayer

RTSP connection address formats are as follows:

- RTSP Stream 1 => <rtsp://camera IP:8557/h264>
- RTSP Stream 2 => <rtsp://camera IP:8556/h264>
- RTSP Stream3 => <rtsp://camera IP:8553/h264>

Stream 3 is for the Panoramic image.

If password authentication is enabled, the RTSP connection address is as follows:

- <rtsp://Username:Password@VC IP address:port/h264>
- To enable password authentication function, please refer to [5.2.8 System Setting - Network](#)

#### Example:

Open the VLC software, click [Open Network Streaming], and enter the URL:

<rtsp://192.168.100.150:8557/h264>

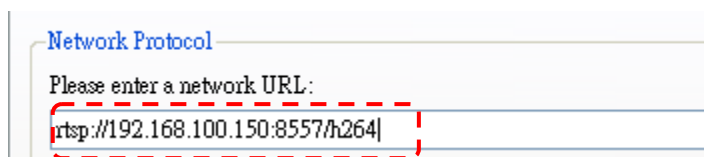
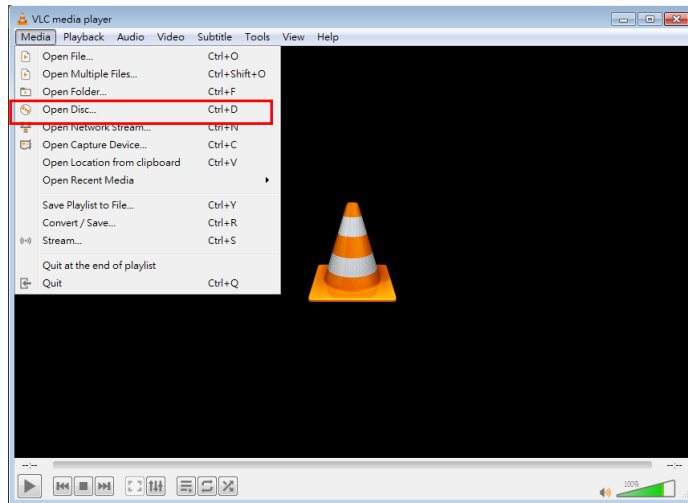

## 5.2 Web Page Menu Function Description

### 5.2.1 Login Screen

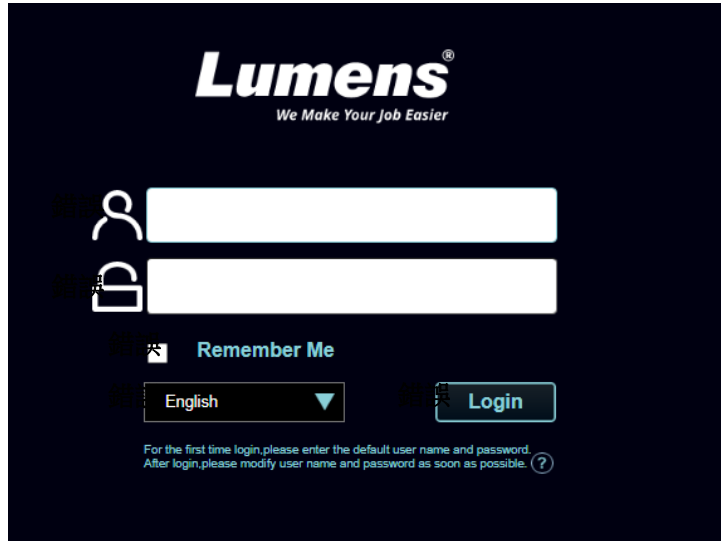

No	Item	Function Descriptions
1	User Login Account	Enter user login account (default: admin)
2	User Password	Enter user password (default: 9999) <Remark> For the first-time login, please refer to <a href="#">5.2.10 System Settings - User</a> to change the default password
3	Remember user account and password	Save user login account and password to the browser. When you log in next time, there is no need to re-enter them
4	Language	Supporting English/Traditional Chinese/Simplified Chinese
5	Login	Log into the administrator screen on the website

### 5.2.2 Live Video – PTZ Control

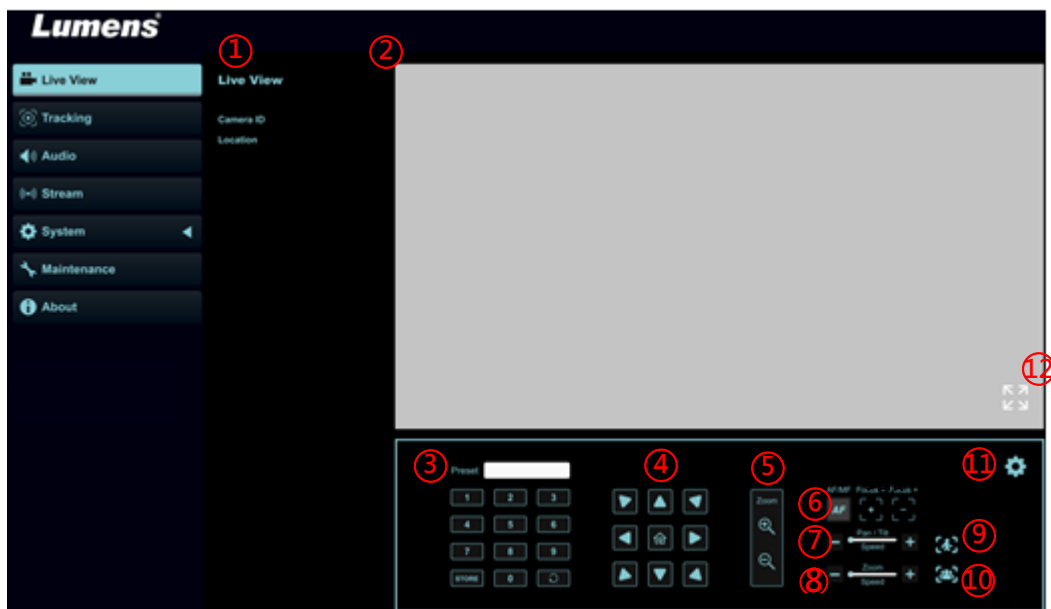

No	Item	Function Descriptions
1	Camera ID/location	Display camera ID/location Please refer to <a href="#">5.2.7 System Settings - Output Setting</a>
2	Preview window	Display the screen currently captured by the camera



3	Preset setting	Select the number first and then select SAVE or LOAD
4	Pan/Tilt setting	Adjust the Pan/Tilt position of the camera screen
5	Zoom	Zoom In/Zoom Out ratio
6	AF/MF	Switch AF/MF
7	Pan/ Tilt Speed	Adjust the horizontal/vertical moving speed of the lens
8	Zoom speed	Adjust the zoom speed
9	Auto Tracking	Enable/Disable Auto Tracking
10	Auto Framing	Enable/Disable Auto Framing
11	Camera Setting	Please refer to <a href="#">5.2.3 Live Video - Camera Setting</a> for related settings
12	Enlarge the preview window	Zooming in/out the preview image

### 5.2.3 Live Video - Camera Setting

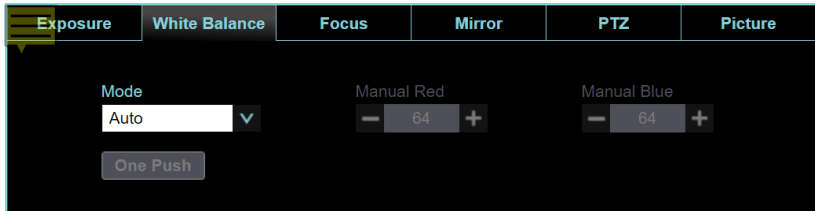
No	Item	Function Descriptions
1	Exposure	<ul style="list-style-type: none"> <li>Mode: Select exposure mode (Full Auto/Shutter Pri/Iris Pri/Manual/ White Board)</li> <li>Gain Level: Adjust the gain level (adjustable only under the “Manual”)</li> <li>Gain Limit: Adjust the gain limit (adjustable only under the “Manual”)</li> <li>Exposure Comp. Level: Select exposure compensation level</li> <li>WDR: Set the level of wide dynamic range (WDR) in order to obtain better images</li> <li>Iris Level: Adjust the size of aperture (adjustable only under the “Manual” or “Aperture Priority”)</li> <li>Shutter Speed: Adjust the shutter speed (adjustable only under the “Manual” or “Shutter Priority”)</li> <li>Anti-Flicker: Enable Anti-flicker function(adjustable 50Hz or 60Hz)</li> </ul>
2	White Balance	 <ul style="list-style-type: none"> <li>Mode: Select the color temperature mode</li> <li>Open Push WB: Single color temperature execution adjustment (adjustable only under the “One Push WB”)</li> <li>Manual Red/Blue: Manually adjust blue/red color temperature</li> </ul>

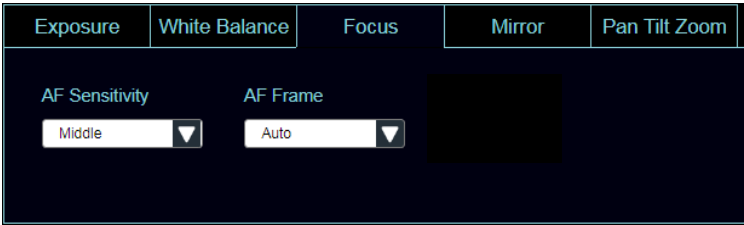
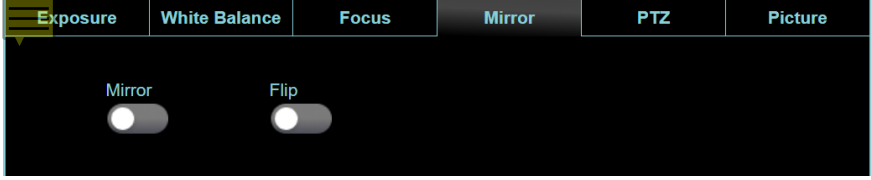
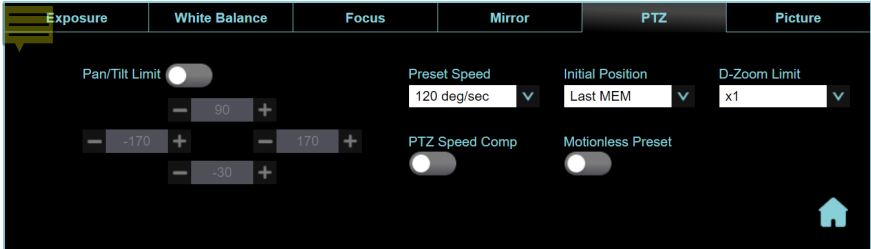
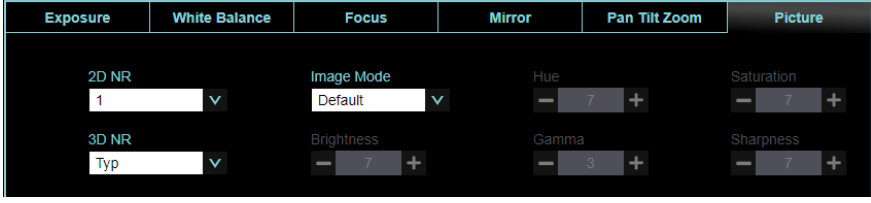
3	Focus	 <ul style="list-style-type: none"> <li>■ AF Sensitivity: Set automatic focus sensitivity</li> <li>■ AF Frame: Set automatic focus range</li> </ul>
4	Mirror	 <ul style="list-style-type: none"> <li>■ Mirror: Set image mirroring</li> <li>■ Flip: Set image flip</li> </ul>
5	Pan Tilt Zoom(PTZ)	 <ul style="list-style-type: none"> <li>■ Pan/Tilt limit: Enable, and set the pan/tilt limit</li> <li>■ Preset Speed: Set the rotation speed of the cradle head when Preset is executed</li> <li>■ Initial Position: Set the camera lens to return to <b>Last MEM</b> or <b>1st Preset</b> after POWER ON  <b>&lt;Remark&gt; 1st Preset = Preset 0</b></li> <li>■ D-Zoom Limit: Set the D-Zoom Limit</li> <li>■ PTZ Speed Comp: After it is activated, the Pan/Tilt moving speed will vary from the zoom position</li> <li>■ Initial Position: Set the camera lens to return to the last operated position or the first preset position after POWER ON  Motionless Preset: When the function is enabled, the screen will Freeze when Preset is executed. Freeze will be released after Preset is completed</li> </ul>
6.	Photo	 <ul style="list-style-type: none"> <li>■ 2D noise reduction: 2D noise reduction settings</li> <li>■ 3D noise reduction: 3D noise reduction settings</li> <li>■ Image Mode: The user may customize his/her desired image mode</li> <li>■ Hue: Hue adjustment of the image; Adjustable when the image mode is set to Custom</li> <li>■ Saturation: Saturation adjustment of the image; Adjustable when the image mode is set to Custom</li> </ul>

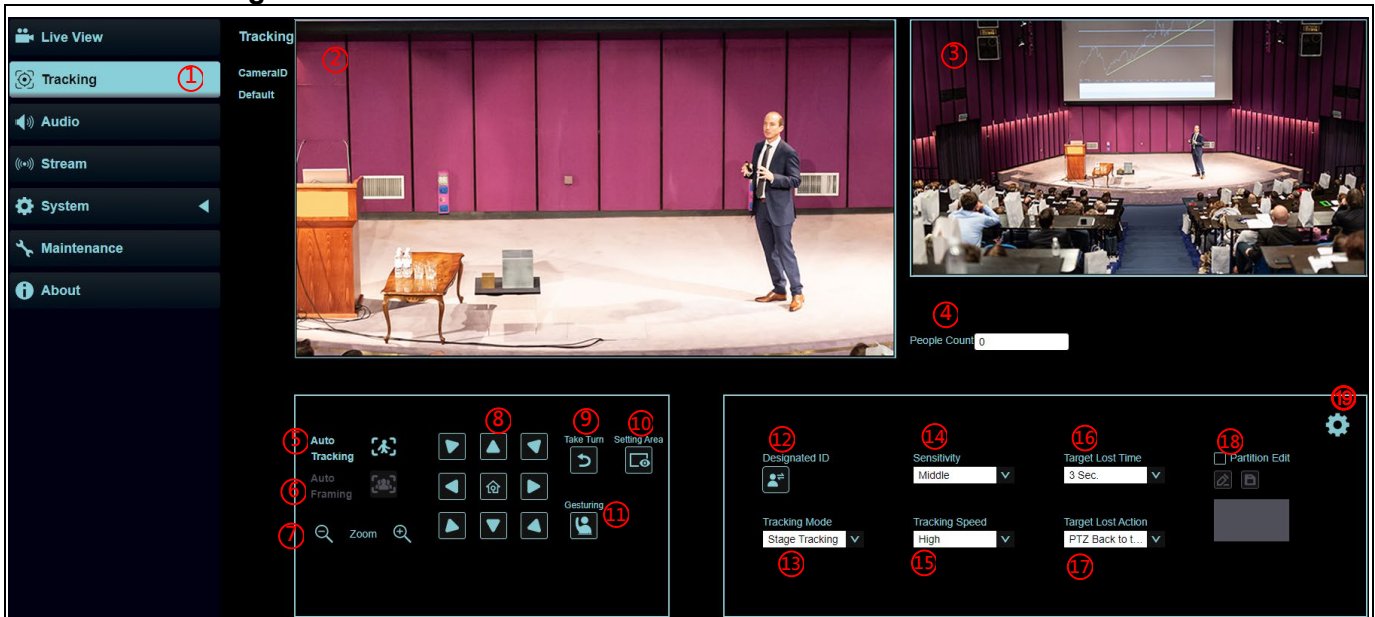

		<ul style="list-style-type: none"> <li>■ Brightness: Brightness adjustment of the image; Adjustable when the image mode is set to Custom</li> <li>■ Gamma: Gamma Level adjustment; Adjustable when the image mode is set to Custom</li> <li>■ Sharpness: Sharpness adjustment of the image; Adjustable when the image mode is set to Custom</li> </ul>
7	PTZ Control	Go back to PTZ Control page

## 5.2.4 Tracking

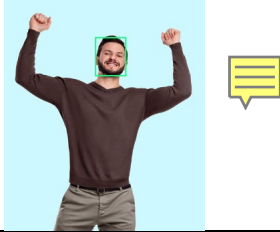

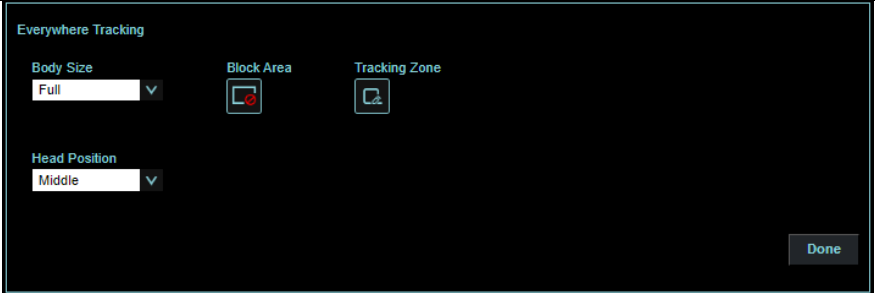
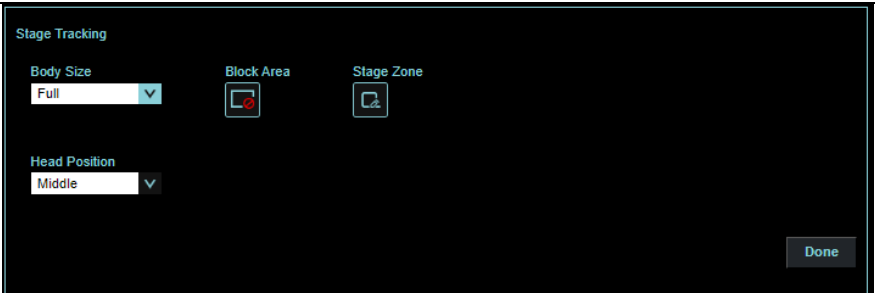
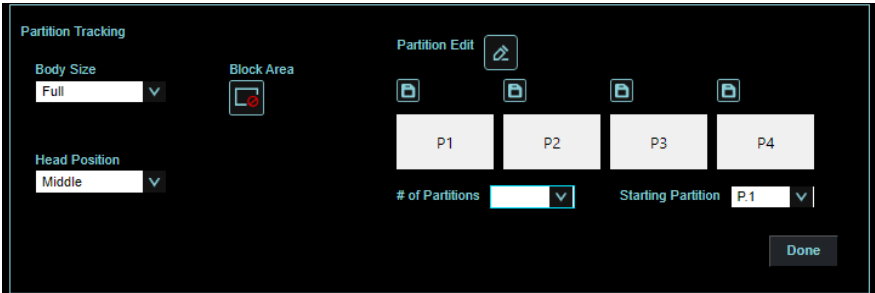
No	Item	Function Descriptions
1	Camera ID/location	Please refer to <a href="#">5.2.7 System Settings - Output Setting</a> to display camera ID/location
2	Preview main window	Display the screen currently captured by the main camera lens <b>&lt;Remark&gt;</b> Left-click the detected person in the screen to switch the tracking object. The tracking object is depicted with a green bounding box
3	Panoramic preview window	Display the screen currently captured by the panoramic lens
4	People Count	Display the number of people in the screen automatically calculated by the system
5	Auto Tracking	Start/Stop Auto Tracking <b>&lt;Remark&gt;</b> Auto Tracking / Auto Framing (Select one only)
6	Auto Framing	Start/Stop Auto Framing The camera will automatically detect the locations of people, and automatically adjust the zoom to the most appropriate size to accommodate all the participants according to change of the number of people in conference <b>&lt;Remark&gt;</b> Auto Tracking / Auto Framing (Select one only)
7	Zoom ratio	Zoom In/Zoom Out ratio
8	Pan/Tilt setting	Adjust the Pan/Tilt position of the camera screen <b>&lt;Remark&gt;</b> When Auto Tracking / Auto Framing is enabled, PTZ settings are not supported
9	Take Turn	Switch the target one by one from left to right. It will be switched once the button is pressed
10	Setting Zone	Display the tracking and block area
11	Gesturing	On/ Off Gesturing function. Support the following gesture, the tracking target will automatically switch when the speaker raises both hands. 
12	Designated ID	Press it to activate this function. You can switch the ID by clicking the targeted frame with the mouse. ※Center Stage mode not support this function.

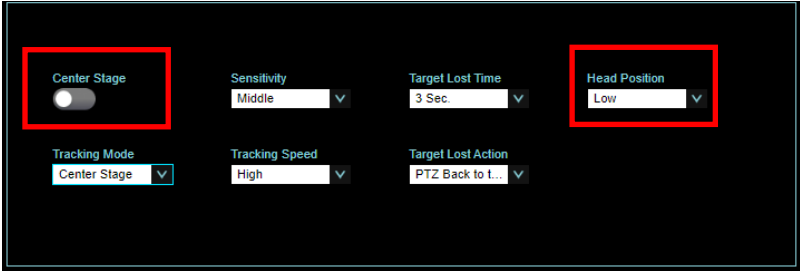

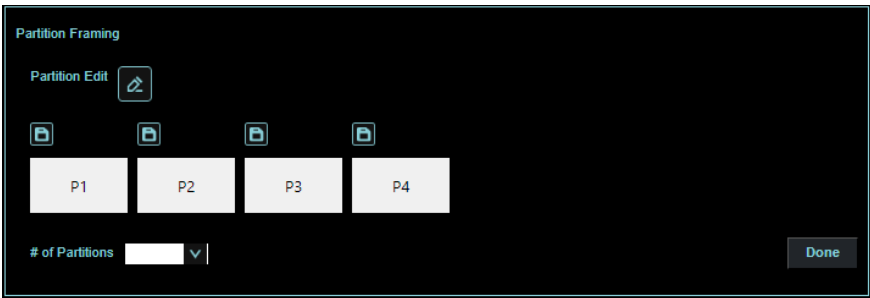
13	Tracking Mode	Set the Tracking Mode (Everywhere Tracking/Stage Tracking/Center Stage/Partition Tracking/Auto-Framing/Partition Framing)
14	Sensitivity	Set tracking sensitivity
15	Tracking Speed	Set tracking speed
16	Target Lost Time	Set a delay for taking action after a tracking object is lost
17	Target Lost Action	Set the action after a tracking object is lost
18	Partition Edit	Check to edit and save the Partition settings.
19	People Count	VC-TR30 supports 6 kinds of tracking mode
19.1	Settings - Everywhere tracking	 <ul style="list-style-type: none"> <li>■ Body Size: Set Full/Half Body</li> <li>■ Head Position: Set the head position of the person in the screen</li> <li>■ Block Area: Click into the Edit mode, frame by holding the left mouse button and set the block area</li> <li>■ Tracking Zone: Set specific tracking range.</li> </ul>
19.2	Settings - Stage Tracking	 <ul style="list-style-type: none"> <li>■ Body Size: Set Full/Half Body</li> <li>■ Head Position: Set the head position of the person in the screen</li> <li>■ Block Area: Click into the Edit mode, frame by holding the left mouse button and set the block area</li> <li>■ Stage Zone: Click into the Edit mode, frame by holding the left mouse button and determine tracking range</li> </ul>
19.3	Settings - Partition Tracking	<p>Set Partition Tracking. Up to 4 zones can be set</p> <p>When a person enters the zone of a partition, the camera switches to the partition. Tracking is not performed in the zone, but everywhere outside the partition</p> <p>Please refer to <a href="#">5.2.4.2 Partition Tracking</a> for the setting steps</p> 

		<ul style="list-style-type: none"> <li>■ Body Size: Set Full/Half Body</li> <li>■ Head Position: Set the head position of the person in the screen</li> <li>■ Block Area: Click into the Edit mode, frame by holding the left mouse button and set the block area</li> <li>■ Partition Edit: Edit, save partition positions and preview the partition image. Click to enlarge the partition image, and then click the enlarge icon to cancel the preview.</li> <li>■ Partition amount: Display total stored number of Partition.</li> <li>■ Starting Partition: Initiating the partition position</li> </ul>
19.4	Setting – Center Stage	<p>Enable Center Stage allow camera keeps target in center of frame based image in PTZ lens after calling a new preset.</p>  <ul style="list-style-type: none"> <li>■ Center Stage: on/off</li> <li>■ Head Position: Set the head position of the person in the screen</li> </ul>
19.5	Settings – Auto-Framing	 <ul style="list-style-type: none"> <li>■ Body Size: Set Full/Half Body</li> <li>■ Head Position: Set the head position of the person in the screen</li> <li>■ Block Area: Click into the Edit mode, frame by holding the left mouse button and set the block area</li> </ul>
18.6	Setting – Partition Framing	 <ul style="list-style-type: none"> <li>■ Partition Edit: Edit, save partition positions and preview the partition image. Click to enlarge the partition image, and then click the enlarge icon to cancel the preview.</li> <li>■ Partition amount: Display total stored number of Partition.</li> </ul>

### 5.2.4.1 Stage Tracking

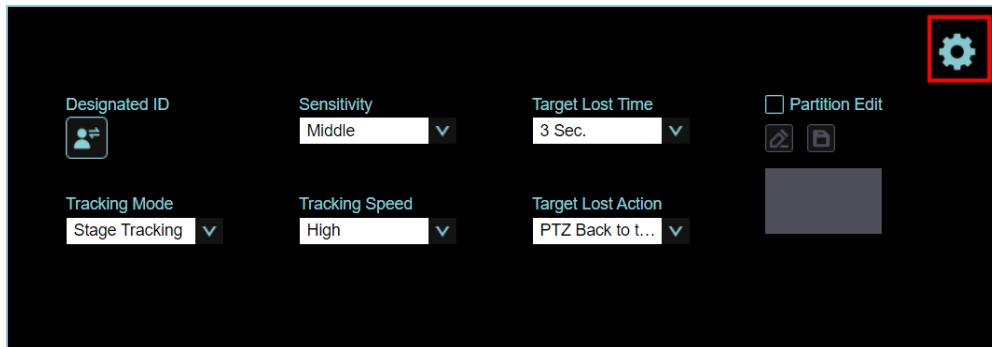
1. Select [Stage] for Tracking Mode, and click  to access the settings



2. Select   Stage Zone to enter Edit mode, and click the left mouse button to frame it (blue frame) in the panoramic preview window, determine the area and moving range. After framing, use the mouse to click the frame line to move or delete it.

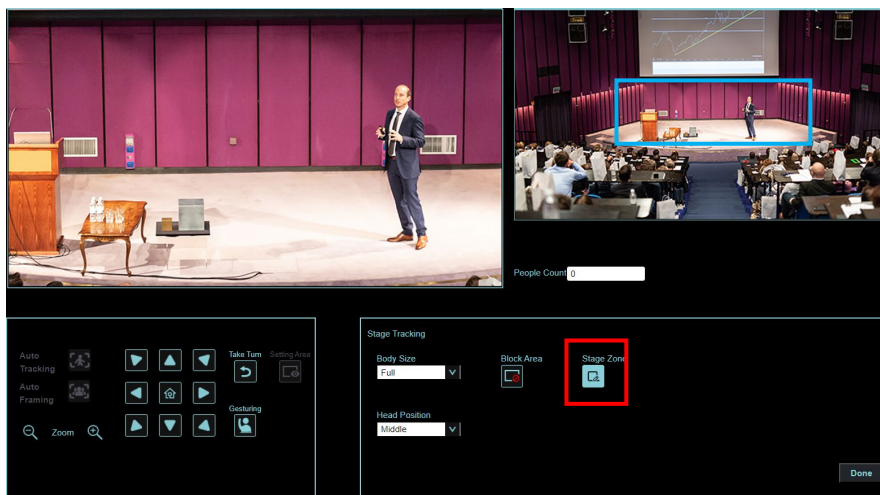

3. Select  to click the left mouse button to frame it (red frame) in the panoramic preview window, and set the block area

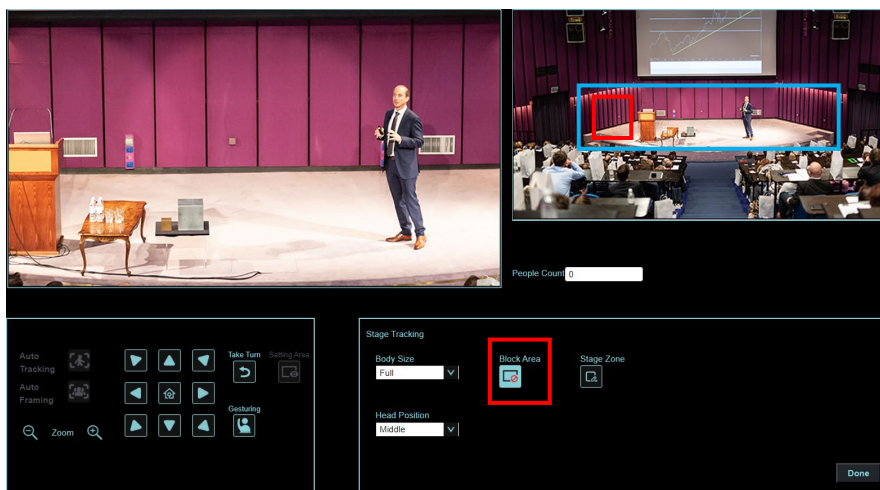



4. After setting completed, click **Done** to save the settings.

5. Click  to enable the Stage feature

### 5.2.4.2 Partition Tracking

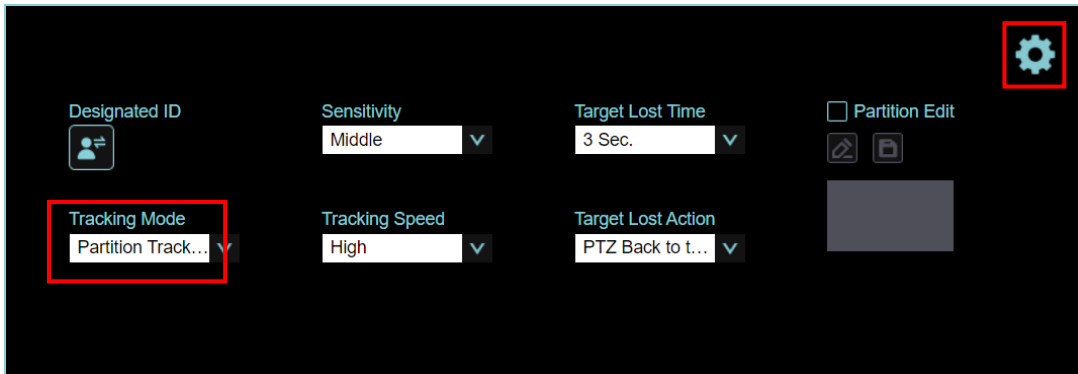
1. Select [Partition] for Tracking Mode, and click  to access the settings



2. Click  to enable the Partition edit, click the left mouse button to frame it (orange frame) in the panoramic preview window, determine the area and click  to save. The partition icon below will be changed to the saved position

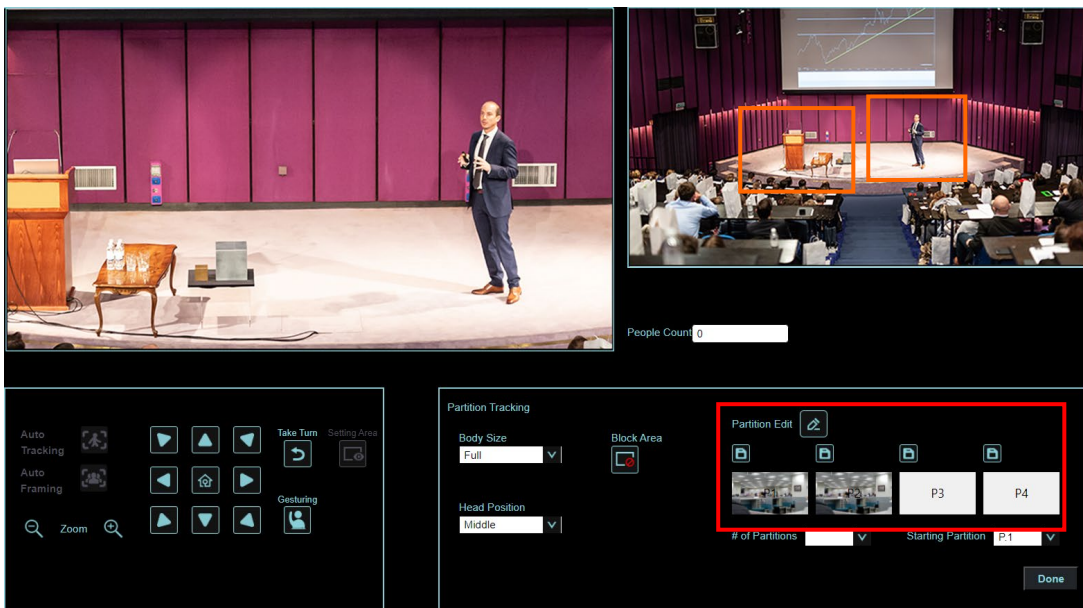

3. After setting completed, click **Done** to save the settings

4. Click  to enable the Partition feature



## 5.2.5 Audio

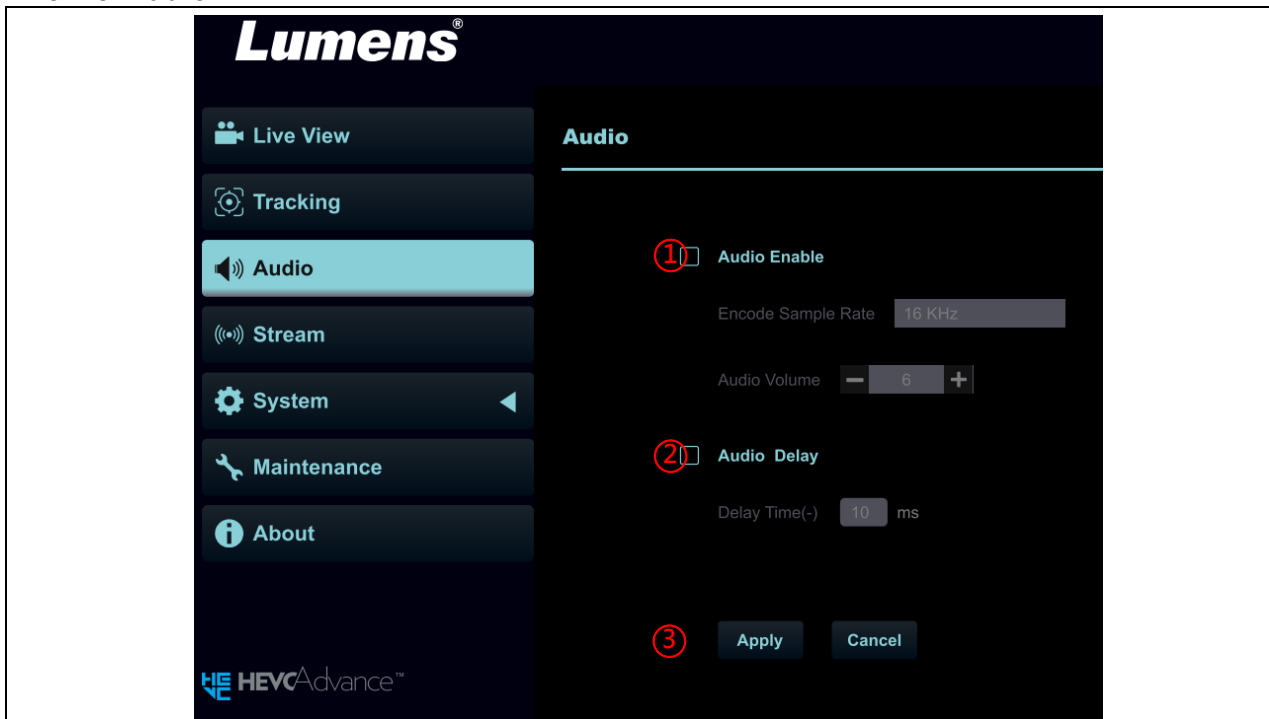

No	Item	Function Descriptions
1	Audio Enable	Select to enable Audio function <ul style="list-style-type: none"> <li>■ Audio In: Set Line In / Mic In</li> <li>■ Encode sample rate: Encode type and sample rate (48KHz(AAC))</li> <li>■ Volume: Adjust Audio Volume</li> </ul>
2	Audio Delay	After checking the box, set the audio delay time (10 ~ -500 ms)
3	Apply/Cancel	Apply/Cancel Audio Setting

## 5.2.6 Streaming

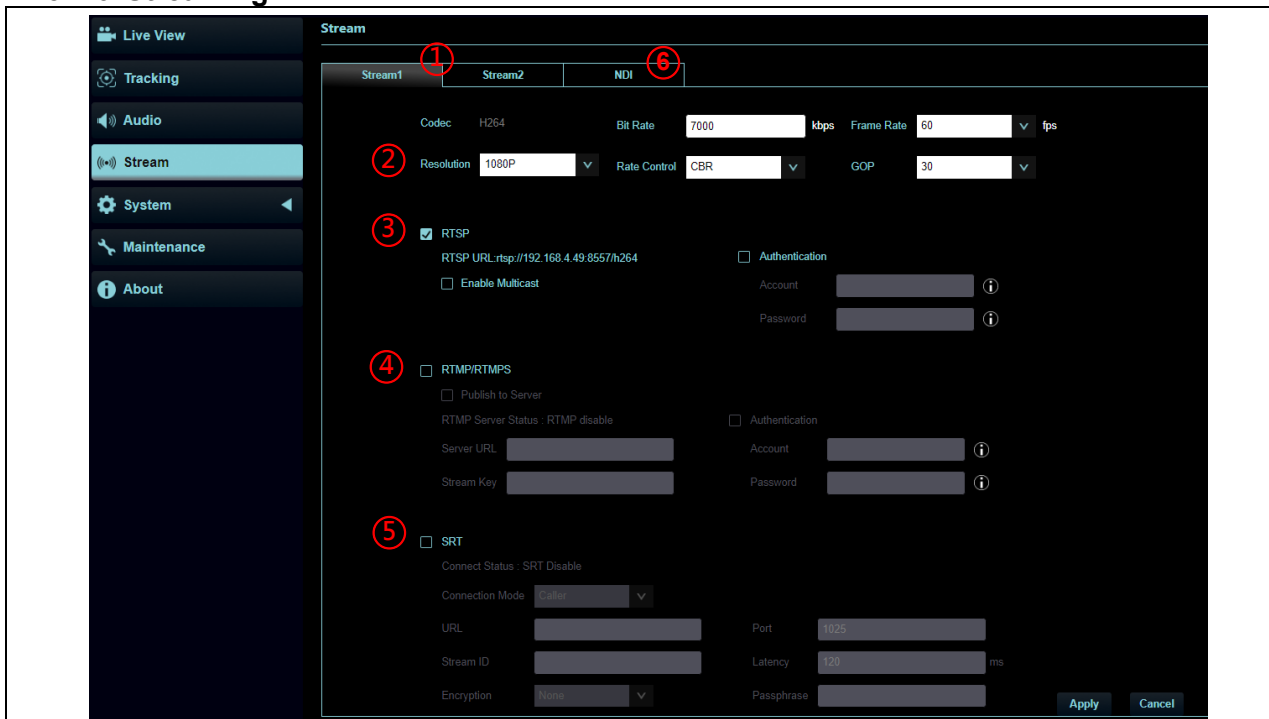

No	Item	Function Descriptions
1	Streaming 1/ Streaming 2	Supporting 2-way streaming output
2	Streaming parameter setting	Please refer to <a href="#">5.2.6.1 Streaming Parameter Setting</a> for relevant settings
3	RTSP	<p>Select to enable RTSP</p> <ul style="list-style-type: none"> <li>■ Enable/Disable Multicast It is suggested to enable Multicast when the number of users online watching the live image simultaneously is more than 4</li> <li>■ Enable/Disable Password Authentication <ul style="list-style-type: none"> <li>➤ RTSP connection format can be found in <a href="#">5.1.3 Using RTSP Player to View the Images</a></li> <li>➤ The username/password is the same as the web login password of the camera, please refer to <a href="#">5.2.10 System Settings - User</a> to add/modify account information</li> </ul> </li> </ul>
4	RTMP/ RTMPS	<p>Copy the RTMP web address provided by the RTMP service platform and paste it to the RTMP connection address to publish the camera images on the RTMP service platform</p> <ul style="list-style-type: none"> <li>■ To upload to YouTube for live streaming, please refer to <a href="#">5.2.5 Audio</a> to turn on the audio function</li> </ul>
5	SRT	<ul style="list-style-type: none"> <li>■ Check to enable and set SRT streaming After the SRT streaming is opened, it will be connected automatically upon startup</li> <li>■ The port number must be set in the range above 1024 with a maximum value of 9999 <b>&lt;Remark&gt;</b> The following port is to be used by the camera. Setting of the said port may not connect correctly 8554, 8555, 8557, 8080, 9090, 1935</li> <li>■ Delay time is for 20 to 8000 microseconds. The default value is 120 microseconds</li> </ul>

5.2.6.1 Streaming parameter setting

Function		Streaming 1	Streaming 2
Encode Format		H.264	
Resolution		1080p / 720p	720p
Bit rate	Range	2,000~20,000	2,000~20,000
	Factory Default	7,000	3,000
Rate Control		CBR / VBR	
Frame Rate		Setting according to the supported resolution	
Group of Pictures		Setting according to the supported resolution	

5.2.7 System – Output

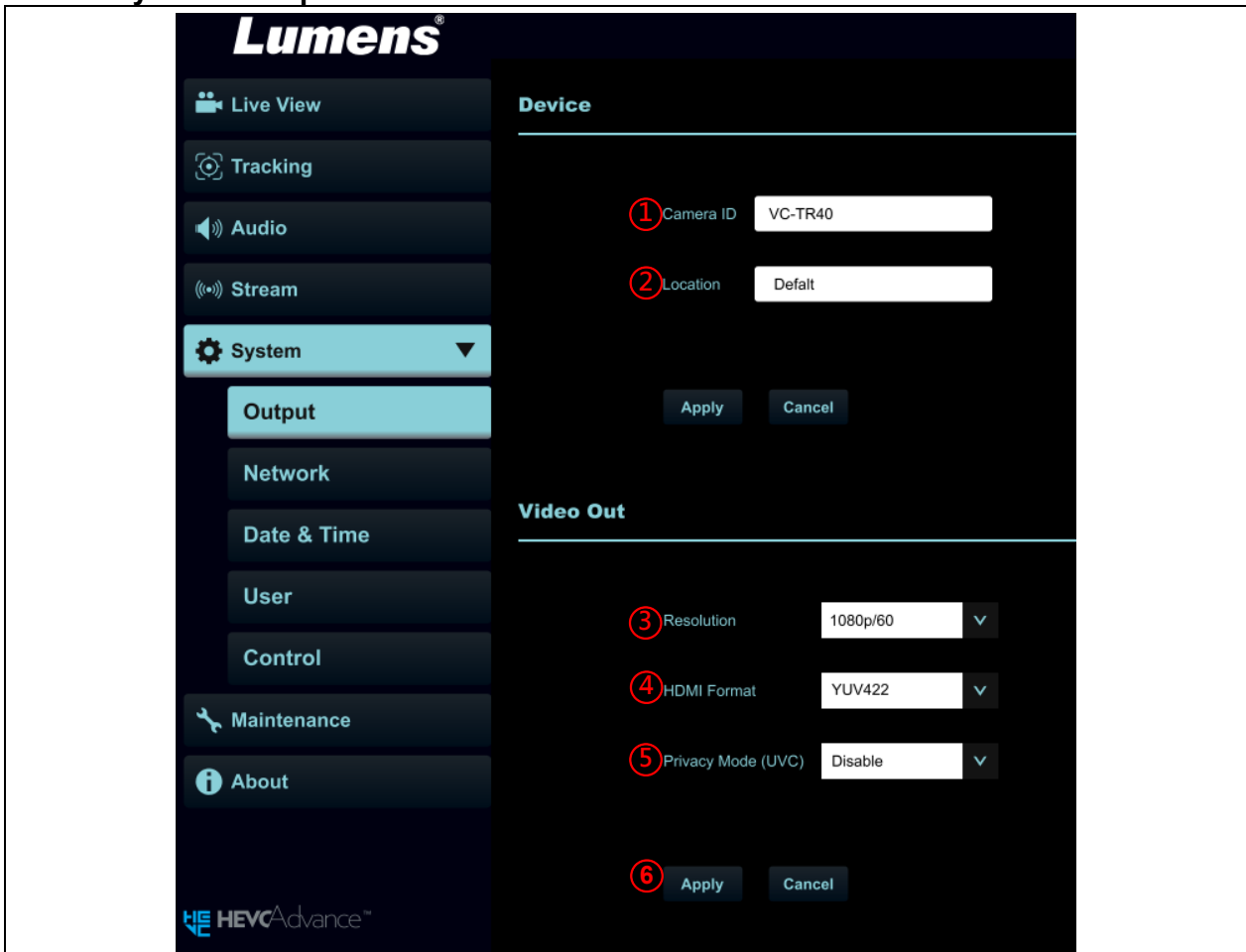

No	Item	Function Descriptions
1	Camera name	Change camera name here <ul style="list-style-type: none"> <li>Supporting 1 - 32 characters for the camera name</li> <li>Please mix uppercase and lowercase letters or numbers for characters. Special symbols such as “/” and “space” cannot be used</li> </ul> <b>&lt;Remark&gt;</b> Modifying this field will modify the Onvif device name synchronously
2	Camera Location	Modify the location of the camera, such as Room 1 <ul style="list-style-type: none"> <li>Supporting 1 -32 characters for the camera location</li> <li>Please mix uppercase and lowercase letters or numbers for characters. Special symbols such as “/” and “space” cannot be used</li> </ul> <b>&lt;Remark&gt;</b> Modifying this field will modify the Onvif device location synchronously
3	Resolution	Set the resolution of the camera

		After switching the resolution, the camera will restart. Please refresh the browser
4	HDMI format	Select YUV444/RGB
5	Privacy Mode (UVC)	Enable/Cancel Privacy Mode After the function is enabled, when the camera is turned off via the remote control or software, the lens will automatically turn to the bottom right to ensure the user's privacy
6	Apply/Cancel	Apply/Cancel Setting

### 5.2.8 System – Network

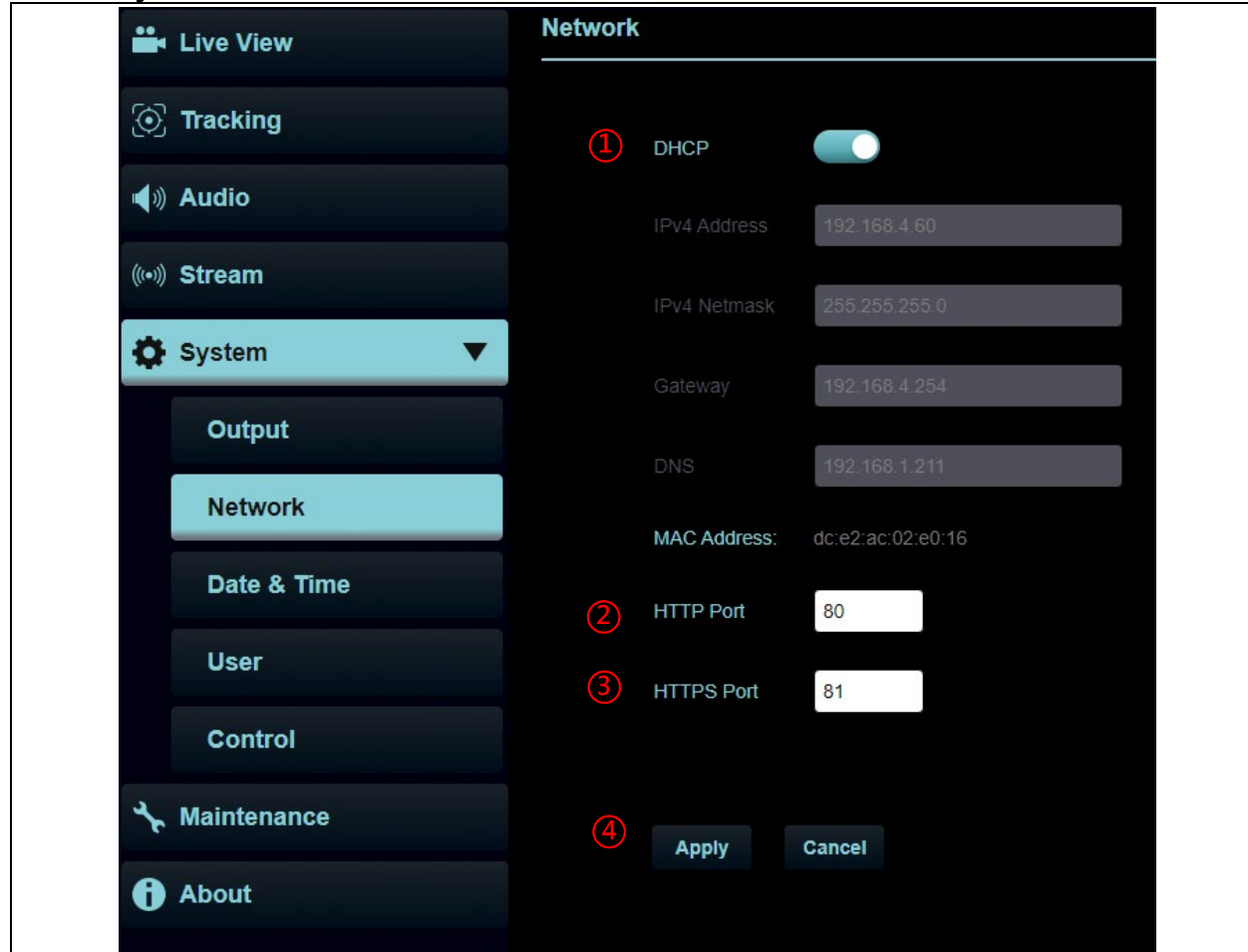

No	Item	Function Descriptions
1	DHCP	Network setting of camera. Change of setting is available when DHCP function is closed
2	HTTP port number	Set HTTP port. The default Port value is 80
3	HTTPS port number	Set HTTPS port. The default Port value is 81
4	Apply/Cancel	Apply/Cancel Setting

### 5.2.9 System – Date & Time

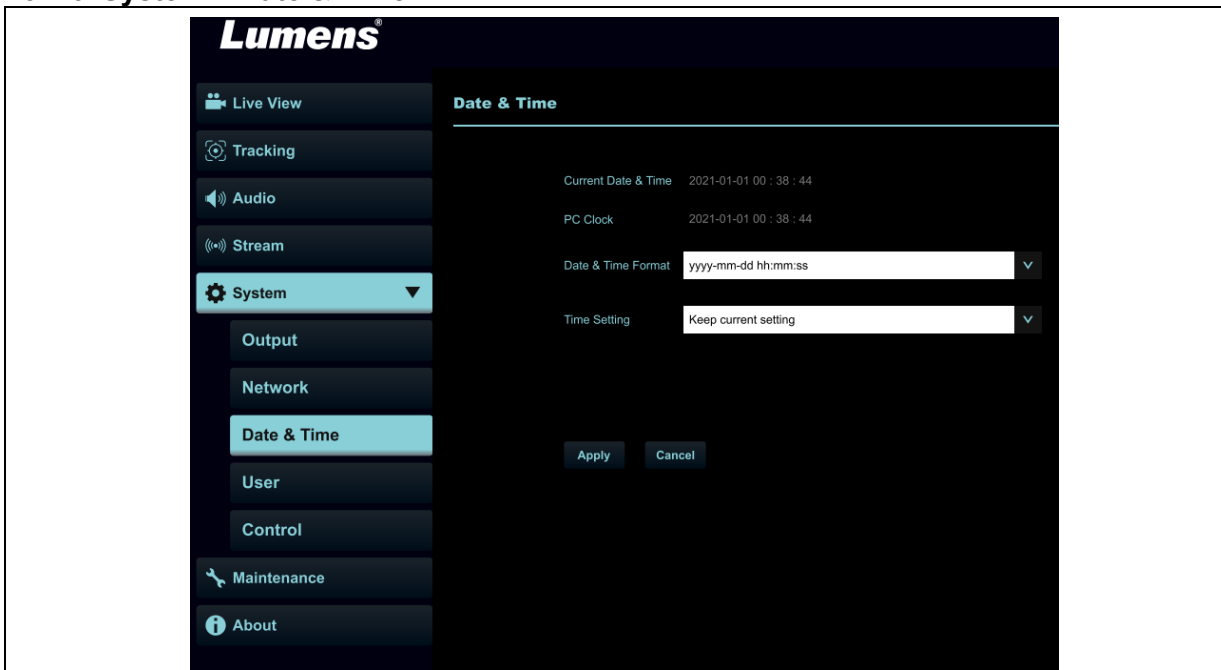

#### Function Descriptions

Display the current camera/PC date and time, and set the display format and synchronization way  
 When Manually Set is selected for [Time Settings], Date & Time can be customized

### 5.2.10 System – User

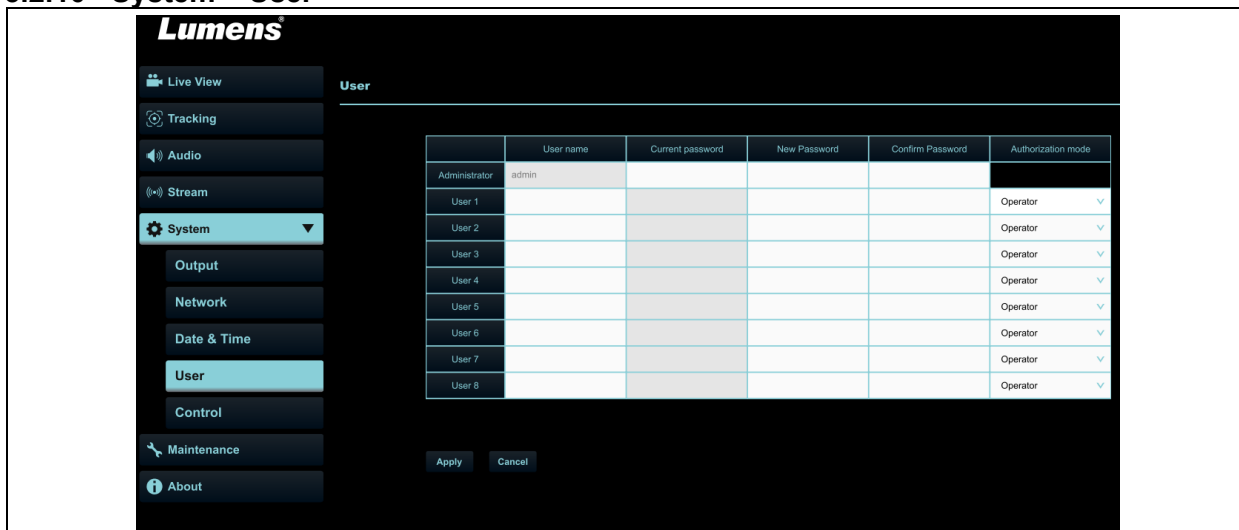

#### Function Descriptions

- Add/Modify/Delete user account
- Supporting 4 - 32 characters for user name and password
  - Please mix uppercase and lowercase letters or numbers for characters. Special symbols or the underlined cannot be used
  - Authentication Mode: Set the new account management permissions

User Type	Administrator (Admin)	Operator (Operator)	Viewer (Viewer)
View images	V	V	V
Settings	V	V	X
Account management	V	X	X

## 5.2.11 System Settings – Control

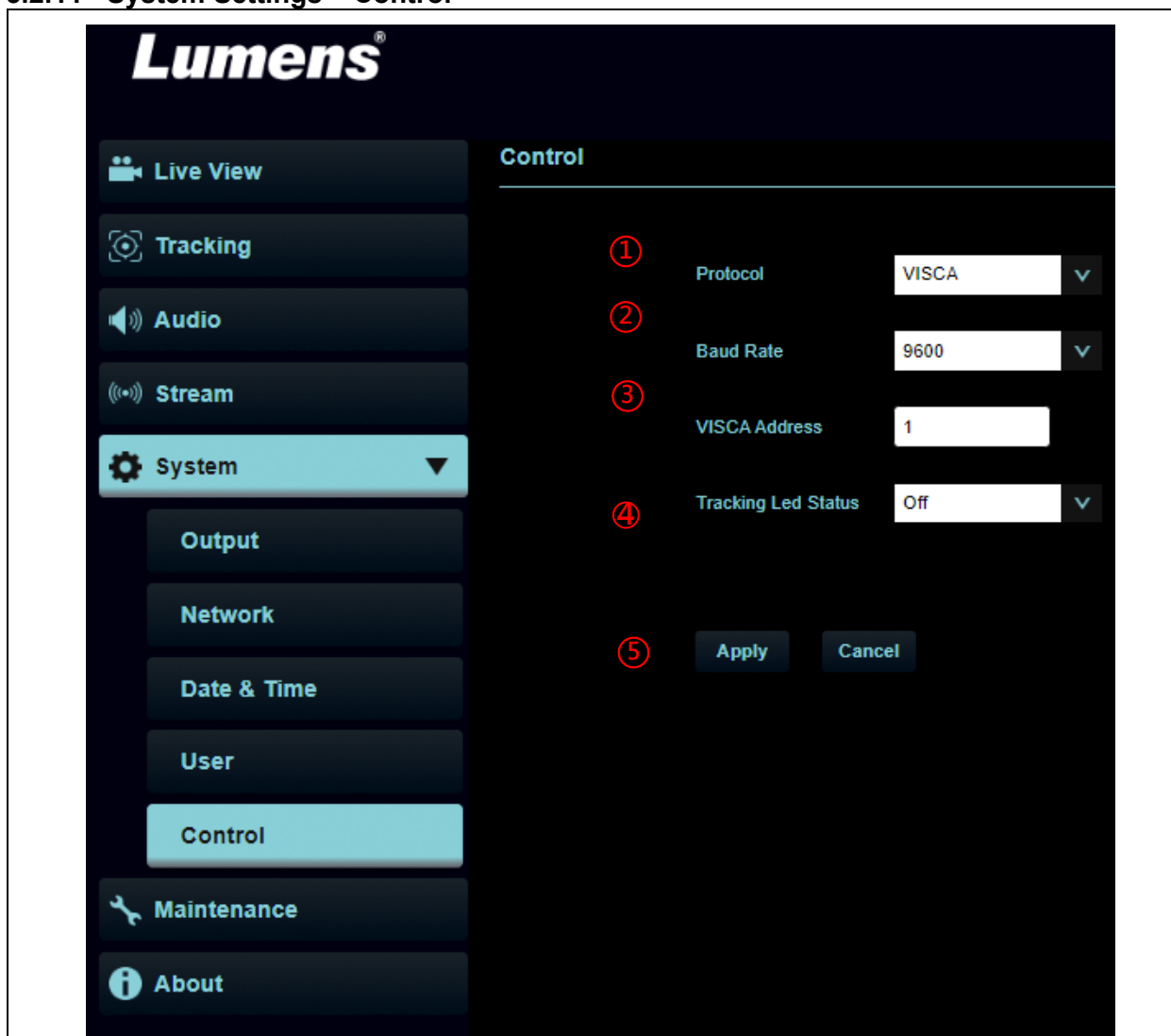

No	Item	Function Descriptions
1	Protocol	Supporting VISCA protocol
2	Baud Rate	Choose the transmission speed of the control signal as 9600/38400
3	VISCA address	The camera ID address 1 ~ 7 can be assigned. Select 0 for automation
4	Tracking LED status	Enable/Disable the LED in front panel flick when tracking is triggered.
5	Apply/Cancel	Apply/Cancel Setting

## 5.2.12 Maintenance

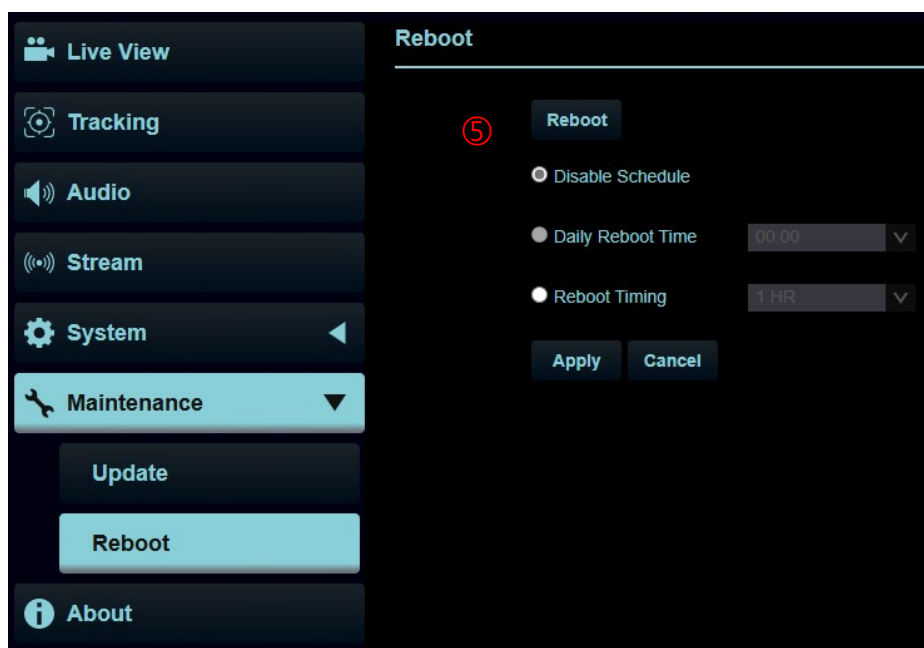
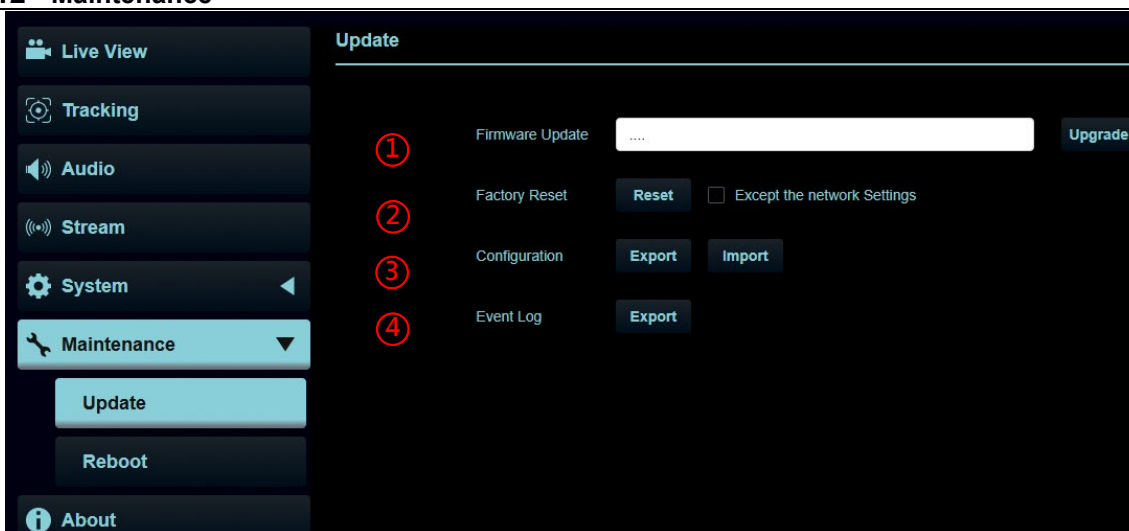

No	Item	Function Descriptions
1	Firmware Upgrade	Select the firmware file, and click [Upgrade] to update the firmware. <b>&lt;Remark&gt;</b> Update takes about 2-3 minutes. <b>&lt;Remark&gt;</b> Please do not operate o-r turn off the power of the device during the update to avoid firmware update failure.
2	Factory Reset	<ul style="list-style-type: none"> <li>■ Reset all configurations to factory default settings</li> <li>■ Except the Network Setting after reset</li> </ul>
3	System Settings	Save setup parameters as a Profile, and users can download and upload camera setup parameters
4	Error Log	If the camera operates abnormally, please export error log and provide it to Lumens for confirmation
5	Reboot	<ul style="list-style-type: none"> <li>• Reboot: Conduct the reboot immediately.</li> <li>• Daily Reboot Time: Choose the desired exact time for the camera to reboot. <b>&lt;Remark: Can only be configured when SNTP is on.&gt;</b></li> <li>• Reboot Timing: Choose how many hours later the camera will reboot: 1HR~24HR.</li> </ul>

## 5.2.13 About



### Function Descriptions

Display the firmware version, serial number, and other related information of the camera

For technical support, please scan the QR code at the bottom right.



## Chapter 6 Troubleshooting

This chapter describes problems you may encounter while using VC-TR30. If you have questions, please refer to related chapters and follow all the suggested solutions. If the problem still occurred, please contact your distributors or the service center.

No.	Problems	Solutions
1.	<b>Boot without power signal</b>	<ol style="list-style-type: none"> <li>1. Make sure you have plugged in the power cord.</li> <li>2. When using a PoE connection, ensure that the power supply supports PoE (IEEE802.3af) hubs</li> </ol>
2.	<b>There is no image output from camera</b>	<ol style="list-style-type: none"> <li>1. Check the power supply or PoE supply functions.</li> <li>2. Confirm the output signals are in streaming output.</li> <li>3. Confirm whether the camera resolution can be used together with the monitor equipment</li> <li>4. Replace the cables and make sure they are not faulty.</li> </ol>
3.	<b>Camera image is severely delayed</b>	Please use 1080p or 720p 60/50 fps rather than 25/30 fps signals.
4.	<b>RS-232 cannot be controlled</b>	<ol style="list-style-type: none"> <li>1. Confirm the connection is correct (RS-232 In/ Out)</li> <li>2. Please make sure the Baud rate setting is the same as the control equipment</li> </ol>
5.	<b>Whether the Internet can be used for operation</b>	Please refer to <a href="#">Chapter 5 Network Function Setting Description</a> for the Internet usage
6.	<b>The ONVIF software cannot find the machine</b>	Please make sure that [System] > [Output] > [Camera ID] / [Location] in the web page uses only English letters or numbers. The ONVIF software cannot find the machine if you use special characters and space.
7.	<b>The camera does not save the relevant parameters (PTZ, AWB ...) after reboot</b>	<p>Please make sure if the Initial Position is set to Last MEM from the setting menu or web page</p> <ol style="list-style-type: none"> <li>1. Setting Menu: System - Initial Position</li> <li>2. Web page: Live View-Setting - Camera Setting - PTZ - Initial Position</li> </ol>
8.	<b>How to log in the portal when you forget your account password</b>	Please contact your Lumens distributor or service center

# Chapter 7 Safety Instructions

Always follow these safety instructions when setting up and using VC-TR30 PTZ Video Camera:

## 1 Operation

- 1.1 Please use the product in the recommended operating environment, away from water or source of heat
- 1.2 Do not place the product on a tilted or unstable trolley, stand or table.
- 1.3 Please clean the dust on the power plug prior to usage. Do not insert the product's power plug into a multiplug to prevent sparks or a fire.
- 1.4 Do not block the slots and openings in the case of the product. They provide ventilation and prevent the product from overheating.
- 1.5 Do not open or remove covers, otherwise it may expose you to dangerous voltages and other hazards. Refer all servicing to licensed service personnel.
- 1.6 Unplug the product from the wall outlet and refer servicing to licensed service personnel when the following situations happen:
  - If the USB port becomes damaged or frayed.
  - If liquid is spilled into the product or the product has been exposed to rain or water.

## 2 Installation

- 2.1 For security considerations, please make sure the standard mount you use is in line with UL or CE safety approbations and installed by technician personnel approved by agents.

## 3 Storage

- 3.1 Do not place the product where the cord can be stepped on as this may result in fraying or damage to the lead or the plug.
- 3.2 Unplug this product during thunderstorms or if it is not going to be used for an extended period.
- 3.3 Do not place this product or accessories on top of vibrating equipment or heated objects.



## 4 Cleaning

- 4.1 Disconnect all the cables prior to cleaning and wipe the surface with a dry cloth. Do not use alcohol or volatile solvents for cleaning.

## 5 Batteries (for products or accessories with batteries)

- 5.1 When replacing batteries, please only use similar or the same type of batteries.
- 5.2 When disposing of batteries or products, please adhere to the relevant instructions in your country or region for disposing of batteries or products.

## ■ Precautions

	This symbol indicates that this equipment may contain dangerous voltage which could cause electric shock. Do not remove the cover (or back). No user-serviceable parts inside. Refer servicing to licensed service personnel.		This symbol indicates that there are important operating and maintenance instructions in this User Manual with this unit.
-------------------------------------------------------------------------------------	-------------------------------------------------------------------------------------------------------------------------------------------------------------------------------------------------------------------------------	--------------------------------------------------------------------------------------	---------------------------------------------------------------------------------------------------------------------------

## ■ FCC Warning

This equipment has been tested and found to comply with the limits for a Class A digital device, pursuant to part 15 of the FCC Rules. These limits are designed to provide reasonable protection against harmful interference when the equipment is operated in a commercial environment.

Notice :

The changes or modifications not expressly approved by the party responsible for compliance could void the user's authority to operate the equipment.

This equipment has been tested and found to comply with the limits for a Class A digital device, pursuant to part 15 of the FCC Rules. These limits are designed to provide reasonable protection against harmful interference when the equipment is operated in a commercial environment.

## ■ IC Warning

This digital apparatus does not exceed the Class A limits for radio noise emissions from digital apparatus as set out in the interference-causing equipment standard entitled "Digital Apparatus," ICES-003 of Industry Canada.

Cet appareil numérique respecte les limites de bruits radioélectriques applicables aux appareils numériques de Classe A prescrites dans la norme sur le matériel brouilleur: "Appareils Numériques," NMB-003 édictée par l'Industrie.

## ■ EN55032 CE Warning

Operation of this equipment in a residential environment could cause radio interference.

Warning: Operation of this equipment in a residential environment may cause radio interference

#### ■ “Extron IP Link Compatible

Extron has developed and tested an IP Link driver for this product. Using IP Link technology, this device can be monitored, controlled and supported over a standard Ethernet network. In order to enable IP Link network connectivity and control, you must install and configure an IP Link-enabled device such as a MediaLink controller or IP Link Ethernet control interface. For more information, please see [www.extron.com/ipic](http://www.extron.com/ipic)”.

# Supplier's Declaration of Conformity

## 47 CFR § 2.1077 Compliance Information

**Manufacturer :** Lumens Digital Optics Inc.

**Product Name :** VC-TR30

**Model Number :** PTZ Video Camera

### Responsible Party – U.S. Contact Information

**Supplier :** Lumens Integration, Inc.

4116 Clipper Court, Fremont, CA 94538, United States

**e-mail :** support@mylumens.com

### FCC Compliance Statement

This device complies with Part 15 of the FCC Rules. Operation is subject to the following two conditions : (1) This device may not cause harmful interference, and (2) this device must accept any interference received, including interference that may cause undesired operation.

# Copyright Information

---

Copyrights © Lumens Digital Optics Inc. All rights reserved.

Lumens is a trademark that is currently being registered by Lumens Digital Optics Inc.

Copying, reproducing or transmitting this file is not allowed if a license is not provided by Lumens Digital Optics Inc. unless copying this file is for the purpose of backup after purchasing this product.

In order to keep improving the product, the information in this file is subject to change without prior notice.

To fully explain or describe how this product should be used, this manual may refer to names of other products or companies without any intention of infringement.

Disclaimer of warranties: Lumens Digital Optics Inc. is neither responsible for any possible technological, editorial errors or omissions, nor responsible for any incidental or related damages arising from providing this file, using, or operating this product.